



Material Collected from a Variety of Sources

Editor takes no responsibility for the veracity of content

September 25, 1999

This Electronic Document is provided by The Sight's 1911 Page
<http://www.win.net/~sydwdn/1911/1911.htm>

Words underlined in **red** like the link above are World Wide Web hyperlinks and you may access the referenced sites by double-clicking on the link if you are logged onto the Web.

From rec.guns: "Is the 1911 .45 an outdated design?"

Of course the 1911 is an outdated design. It came from an era when weapons were designed to win fights, not to avoid product liability lawsuits. It came from an era where it was the norm to learn how your weapon operated and to practice that operation until it became second nature, not to design the piece to the lowest common denominator. It came from an era in which our country tried to supply its fighting men with the best tools possible, unlike today, when our fighting men and women are issued hardware that was adopted because of international deal-making or the fact that the factory is in some well-connected congressman's district.

Yes, beyond any shadow of a doubt, the 1911 IS an outdated design....and that's exactly what I love about it.

Rosco S. Benson



Table of Contents

| | |
|--|----|
| 1911..... | 1 |
| M1911 vs. M9 | 1 |
| Elements of the Mystique | 2 |
| Debunking the Myths..... | 4 |
| Syd's History of the 1911 | 5 |
| John Browning History | 10 |
| Browning Arms Company..... | 11 |
| Who Made It? | 13 |
| 1911 Magazine FAQ..... | 15 |
| 10-Round Magazine Test..... | 17 |
| Geoff Beneze about Add-Ons | 17 |
| The Conditions of Readiness | 18 |
| Firing Pin Safety and Accidental Discharge | 19 |
| Winchester Reloading Data..... | 20 |
| The .45 ACP Cartridge | 21 |
| Pet Loads for 1911 | 24 |
| Glock vs. 1911 | 27 |
| Legends of the 1911..... | 30 |
| My Favorite 1911 Web Links | 37 |
| Recoil Spring Selection | 38 |
| USAMTU Rebuild Specifications | 39 |
| Why Your 1911 Pistol Won't Work | 45 |
| Theory of Operation of the Colt .45 ACP Pistol | 52 |
| In Praise of the M1911 .45 ACP Pistol..... | 55 |
| Concealed Carry and the Large Auto Pistol..... | 57 |
| In Closing..... | 59 |





1911

The 1911 .45 ACP has a mystique that is unmatched by any other pistol. Its owners are devoted to it. It continues to be chosen by SWAT, special forces, and competitive shooters despite challenges by newer designs and technologies. It is a cultural icon and symbol of America at its combative best. Yes, it's a combat sidearm, not a pocket gun or a concealment piece. It was designed for the Army in an era when the cavalry rode into battle on horses. Created by John M. Browning at the turn of the 20th Century, the 1911 was the climax of a series of autoloader designs which culminated in the adoption by the Army of the M1911 in the year from which it took its name. It is perhaps the most loved, studied, and enduring pistol design of all time.



M1911 vs. M9:

In 1985, the United States Armed Forces replaced the M1911 with the Beretta 92 F to the everlasting consternation of 1911 devotees everywhere. There were several reasons for the switch. The U.S. was the only NATO country not using a 9mm as the standard issue sidearm and there was a desire to issue a pistol chambered for the ubiquitous 9mm for logistical reasons. The Beretta will hold 15 rounds in its magazine as compared with 7 rounds of the military issue 1911 magazine and is lighter and easier to field strip than the 1911. The double action/single action Beretta was perceived as being a safer pistol to carry in a state of readiness than the "cocked and locked" 1911. In some quarters, the .45 ACP was viewed as too powerful and difficult to control for those having only nominal training with the weapon.

Defenders of the 1911 will vehemently contest these last three perceptions, pointing to the superior trigger and durability of the 1911, and the superior stopping power and inherent accuracy of the .45 ACP cartridge. In terms of safety, three conditions must be met for the cocked and locked 1911 to fire: (1) a firing grip must depress the grip safety; (2) the manual safety must be taken off, and (3) the trigger must be pulled. Nevertheless, it looks scary and the Armed Forces have documented negligent discharges from improperly handled pistols.

It could be said that the 1911 fell victim to its own mythology. I grew up hearing the stories of the .45—that it kicked so badly that an inexperienced person couldn't hit a door from twenty feet away with one, that a man, struck anywhere on the body by a .45 round would be knocked down as if hit by a truck, and that you could shoot down a Japanese Zero with a .45. (A Zero was downed with a .45 but by a head shot on the pilot by an American aviator parachuting from a bomber. The Zero was trying to strafe the American.) In 1998 The FBI S.W.A.T. team adopted the Springfield 1911A1 as standard issue. Anecdotal evidence out of Desert Storm indicates that the Berettas jammed because of the fine sand in the desert and the Marines broke out the 1911's.

My Own Opinion:

The M9, Beretta 92 F, has the smoothest slide and the lightest recoil spring of any major caliber pistol I know of. When you rack the slide of the M9, you can feel the precision and quality of its manufacture. Those bottomless 15-round magazines could prove to be life savers should you decide to shoot it out with the Crips or invade a small foreign country. My wife is of the opinion that the Beretta is the nicest shooting autoloader around. It has a very good trigger for a DA/SA and the long barrel and sight radius give it adequate accuracy.

Too bad the 92 F is a 9mm. The 9mm is a reasonable defensive round. It will do its part if you do yours, but of course, the same could be said of a .32 caliber pocket gun. Questions have been raised about the “stopping power” of the 9mm and people whose lives depend on their handguns have been migrating away from the 9mm and toward the .40 S&W and .45 ACP in recent years. If I had to shoot someone and I had one shot to do the job, I’d rather that shot be a 230 grain .45 ACP.

My target and competition gun is a Government Model Springfield 1911A1. The question of “inherent accuracy” is the grist of endless debates, but I do believe that some cartridges are more inherently accurate than others. I base this on nothing more than my own experience with shooting them. In my hands, .38 and .45 are more accurate rounds than 9mm and .40 S&W. I shoot .45 with much greater accuracy than I do 9mm, so it is more rewarding for me to shoot .45 for fun and competition. .45 ACP is heavier and more expensive than 9mm, and folks who are particularly recoil sensitive will enjoy the 9mm more than the .45. Last, but not least, 9mm pistols tend to be lighter and more comfortable to carry than 1911s, although some lightweight models of the 1911 are beginning to appear.

Did the Armed Forces make a good choice? I hope so. The M1911 isn’t the best gun for a beginner. In an absolute sense, the M9 is probably safer at ready than a M1911, although, in the hands of a trained person, the 1911 is perfectly safe. The additional rounds might also be an advantage to the nominally trained soldier or law enforcement officer possessed of marginal marksmanship. Which one do I like the best? The M1911, of course.

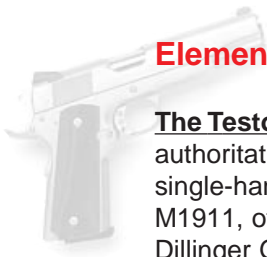

Elements of the Mystique

The Testosterone Factor - “.45” is synonymous with “big, powerful pistol.” The gun goes off with authoritative thunder, a “boom” not a “crack.” Just the sight of this gun evokes images of Sgt. Alvin York single-handedly capturing a regiment of Germans accompanied only by his `03 Springfield and his M1911, of John Wayne in “Sands of Iwo Jima”, and the Texas Rangers. Our villains are there too: the Dillinger Gang with their 1911 accessorized with the front grip and magazine of a Thompson submachine gun, Dutch Schultz, Bonnie and Clyde. It’s a big pistol. It looks big and feels solid. It launches a big 230 grain bullet and delivers over 550 ft.lbs. of energy on impact.

Individuality and Customization - Any new-in-the-box 1911 is really a custom kit. The 1911 is to handguns what the `57 Chevy is to hotrods or the P-51 Mustang to air racers, the ultimate platform for customization. Pistoleros inclined to tinkering eventually find their way to the 1911. Aftermarket parts abound for this pistol, and you can make it into almost anything your heart desires. The design requirements for the pistol specified a gun which could be serviced in the field with a minimum number of tools, and it can be completely disassembled with a screw driver and a punch. Consequently, the 1911 is very accessible from a mechanical point of view. It is relatively easy to install custom parts or modify existing ones. Few 1911s remain completely stock for very long, unless they are those models which include the custom features usually added to the mil-spec guns, such as extended beavertails, custom triggers and hammers, full length guide rods, and decorative grips. For those who seek a personalized sidearm, the 1911 is one of the best platforms from which to begin.

Accuracy - The 1911 is one of the most accurate autoloaders ever built. The original government issue 1911s were built with generous tolerances in order to keep them functioning in combat conditions. Hence, they were reasonably accurate, but not outstanding. Gunsmiths learned to tune the military surplus guns for greater accuracy by tightening the slides and adding match grade barrels and bushings. Newer incarnations of the 1911 are built to tighter tolerances, yielding pistols with outstanding accuracy. The long 5” barrel of the Government Model is also an asset, but pistols with shorter barrels also display great accuracy. In my own opinion, a modern 1911 is generally a more accurate handgun than the .45 offerings of leading makers such as SIG, Glock, H&K, and Smith & Wesson.

The single action trigger of the 1911 is its glory and curse. The 1911 must be cocked, either by hand (not recommended) or by racking the slide. You cannot cock the hammer by pulling the trigger as is done

with a double action revolver or autoloader. For this reason, the pistol must be cocked and locked with the manual safety on in order to be ready to fire quickly. Browning's 1911 prototype did not have the manual safety at all. Browning felt that the grip safety was sufficient, but the Army disagreed and directed Browning to add the thumb activated manual safety on the side of the frame. Even with the double safety configuration, the Army remained jumpy about the action and trained soldiers to carry the pistol hammer down on an empty chamber.

This action, the source of so much anxiety, is also the basis for the pistol's accuracy, speed, and consistency. Since there is no double action linkage to add resistance and catches, the trigger pull of the 1911 is very short and light, requiring only about 5 lbs. of pressure to fire. Every shot is the same since there isn't the long, hard, cocking pull of the first shot of a DA/SA auto. The result is better trigger control and consistency.

Power - The .45 ACP is a proven stopper. The only other handgun cartridge which has demonstrated stopping power comparable to the .45 ACP is the 125 grain .357 Magnum jacketed hollowpoint. The Army moved to the .45 caliber bullet after the failure of the .38 Long Colt to stop the Moro tribesmen in the Philippines. Contrary to popular myth, the .45 ACP was not issued in the Philippines during the Moro uprising, but the experience with the Moros led the Army to specify the .45 for its new autoloader. The Moros used religious ritual and body binding to put themselves into an altered state of consciousness prior to battles, and the .38 Long Colt would not adequately stop these highly motivated warriors. Moving forward a century, law enforcement is again looking to the brute force stopping power of the .45 ACP to deal the current generation of criminals, many of whom use drugs which numb the senses, suppress the response to systemic shock, and repress the survival instinct. While ballistics mavens may argue the merits of their particular pet cartridges, few would argue that there is a better pistol cartridge than the .45 ACP. It has been decisively stopping fights for longer than most of us have been on this troubled little planet.

The Last of the Cowboy Guns - In some ways, the 1911 is the last of the cowboy guns. It was, after all, a product of the 19th Century, designed as a sidearm for horse-mounted cavalry, and carries the single action legacy of the old cowboy six guns from Samuel Colt. Only a few other autoloaders adopted the single action trigger such as the Llama .380, the Colt Government .380, and the Browning Hi-Power, Browning's last, and perhaps, most elegant design. Other pistol designers did not adopt the grip safety and tended to follow the double action/single action pattern being used in French and German pistols built by FN, Walther, and Mauser. The 1911 launches a big, slow bullet, hearkening back again to the six shooters of the fabled Old West. The Europeans, by way of contrast, tended to favor the smaller and faster cartridges such as the .32, .380, and 9mm Luger.

Cocked, locked and ready to rock - From Chuck Taylor, "The controls of the 1911 are well-located for quick, efficient use and require no fine motor skill to operate, a major advantage when the adrenaline is pumping through your veins like a high-pressure pipeline. In fact, the slide stop/release, magazine release button and thumb safety of the M1911 are so easy to operate that no additional training is required. Even when the gun is being presented from a holster, proper training technique incorporates disengagement of the thumb safety at the appropriate time. As practical firearms go, we'll search far and wide for something as easy to use effectively, particularly under stress, as Old Ugly."

Tenure - Some designs capture our imaginations and become archetypes by virtue of their success and staying power: The Single Action Colt Revolver, the Snubnose .38 Special, the 30-30 Winchester lever-action Rifle, The AK-47, the Winchester 12 gauge pump shotgun, the bolt action Mauser rifle, and the M-16. The 1911 is one of these enduring design archetypes. I know of no other firearm introduced in 1911 which is still in production virtually unchanged. Today, scores of manufacturers produce 1911-pattern guns, and many more make their living through customizing and servicing the venerable hand cannon. The 1911 is an extremely durable design and it is not uncommon to find 1911's with a service life of 150,000 rounds. Perhaps we like the things which endure, those things which have been battle tested and validated time and time again. Maybe it's just a really good design that we like. Regardless of the explanations, the sheer staying-power of the 1911 .45 ACP is an element of its mystique.



Debunking the Myths

It could be said that the 1911 fell victim to its own mythology. I grew up hearing the stories of the .45-- that it kicked so badly that an inexperienced person couldn't hit a door from twenty feet away with one, that a man, struck anywhere on the body by a .45 round would be knocked down as if hit by a truck, and that you could shoot down a Japanese Zero with a .45.

You can't shoot down zeroes, blow up Tiger tanks, or sink the Bismark with a 1911 .45 ACP.

Handgun bullets do not generate enough force to knock down an adult human being--if they did, they would knock us down when we fired them. This is simple physics. People do fall down most often when shot with a .45 because they are dead, seriously injured, or responding to the shock, but not because the force of the projectile is pushing their body down. The image of someone flying backwards after being hit by a pistol round is pure Hollywood, but not of the real world.

Far from being uncontrollable, the Government Model 1911 is very controllable. Why would Bullseye and tactical competition shooters the world over choose a gun that was uncontrollable and hard to hit with? Many shooters, especially those with smaller hands, find the 1911 .45 to be more controllable and enjoyable to shoot than the wonder nines. Some of this may have to do with the grip of the 1911, one of the best ever designed, compared to the bulky grips of the high-cap nines, and some of it may have to do with the recoil characteristics of the different cartridges. The fact is the the 1911 remains one of the easiest pistols to shoot well in the world. It's one of the main reasons we love them. They're fun.

Recoil is in the mind of the beholder. There are two kinds of recoil: actual and perceived. It is the perceived recoil that matters to most people. Some people are not recoil sensitive at all; they hardly even notice it. Others are scared by it and can develop a flinch in their trigger pull in anticipation of the kick. Some people actually enjoy the recoil of a powerful gun, and it enhances their experience of shooting. In my own opinion, perceived recoil is a matter of the geometry of the hand on the grip and the weight of the gun. The most unpleasant recoil of any gun I shoot is from from the Airweight Smith & Wesson .38 Special snubnose. The gun has a small grip and a very light frame. It hurts my hands far worse than a .45. Others, with smaller hands, say the opposite, that the .45 kicks much harder than the .38. A Smith & Wesson 6906 9mm which weighs 26 ounces has a sharper recoil than a Government Model 1911 weighing 39 ounces, or at least, it seems that way to me.

All 1911's need custom gunsmith work to operate reliably. 1911's have an ill-deserved reputation for being fussy about feeding ammunition "out of the box" and consequently it has become something of an article of faith in the 1911 community that the first thing one must do with a new 1911 is to send it off to a gunsmith for expensive reliability tuning. Ironically, much of this bad rep is the result of accuracy tuning by gunsmiths trying to get the lockup so tight that the gun will shoot half inch groups at 50 yards. Although a few pistols built by master gunsmiths may approach this level of accuracy, pistols really don't deliver this kind of accuracy for the most part, especially guns tuned for reliability and tactical applications. A reasonable expectation of a quality "out of the box" 1911 is 2.5" groups at 25 yards. With that said, the 1911 was designed with the 230 grain FMJ "hardball" cartridge in mind, and you will get the best performance out of a 1911 with a cartridge which is close to the original in shape. A 1911 built to the tolerances of the mil-spec 1911A1, properly broken in and lubricated, is a highly reliable weapon system. A skilled gunsmith or custom shop can do accuracy tuning on them and get "match grade" accuracy without sacrificing reliability, but accuracy tuning is a slippery slope with a 1911 that, if overdone, can compromise reliability.



Syd's History of the 1911

We identify genius by its impact. It changes things and its vision endures. In the world of firearms, there is one designer whose work changed everything and endures, John Moses Browning. Browning is most frequently remembered as the designer of the 1911 .45 ACP and the Browning High Power, but he also created the Winchester 30-30, The Winchester Pump Shotgun, The Browning Auto-5 Shotgun (produced by Remington as the Model 11), The BAR (Browning Automatic Rifle) and the Browning .50 caliber Machine Gun, plus most of the .30 cal and .50 cal machine guns produced by Colt and used in WW II. He is credited with 128 gun patents, and some fifty million sports and military weapons were manufactured from those patents during the forty-seven years he was an active inventor.

During the same time frame that John Browning was putting the Winchester Repeating Arms Company on the map, a highly motivated tribe of warriors, known as the Moro, were giving the U.S. Army fits in the Philippines. To prepare for battle, the Moro used a combination of body binding with leather, narcotics, and religious ritual to put themselves into an altered state of consciousness which left them insensible to injury. Soldiers found that their revolvers chambered in .38 Long Colt simply would not stop the Moro. It should be noted that their .30 Krag rifles didn't do a whole lot better against these warriors.



Colt Model 1910 (No Manual Safety)

John Browning began to experiment with self-loaders in 1889, inspired by Hiram S. Maxim who had invented a machine gun six years earlier. Browning converted a Winchester 1873 lever-action to an autoloader by using the action of the gases at the muzzle. A machine gun using this same operating principle was built in 1890 and 1891. From this work evolved a machine gun design ultimately built and sold by Colt as the Model 1895 machine gun, popularly called the "Browning Potato Digger" because of its downward arcing, gas-operating piston system. Browning's first self-loading pistol was also a gas-operated weapon.

Based on the experience with the Moros, an Army Ordnance Board headed by Col. John T. Thomson (inventor of the Thomson sub-machine-gun) and Col. Louis A. La Garde, determined that the Army needed a .45 caliber cartridge to provide adequate stopping power. In the mean time, Browning who was working for Colt, had already designed an autoloader pistol, around a cartridge similar in dimension to the .38 Super. When the Army requested designs for a new handgun, Browning re-engineered this .38 autoloader to accommodate a .45" diameter cartridge of his own design with a 230 gr. FMJ bullet, and submitted the pistol to the Army for evaluation.

The selection trials began in 1906 and Browning's pistol faced competition from pistols submitted by Colt, Luger, Savage, Knoble, Bergmann, White-Merrill and Smith & Wesson. Browning's design and the Savage design were selected in 1907. The Army called for additional tests of function and reliability which revealed that neither Colt's nor Savage's offerings had reached the desired perfection. The Ordnance Department instituted a series of further tests and experiments, which eventually resulted in the appointment of a selection committee in 1911.

Browning was determined to prove the superiority of its handgun, so he went to Hartford to personally supervise the production of the gun. There he met Fred Moore, a young Colt employee with whom he worked in close cooperation trying to make sure that each part that was produced for the test guns was simply the best possible. The guns produced were submitted again for evaluation to the committee. A torture test was conducted on March 3rd, 1911. The test consisted of having each gun fire 6000 rounds. One hundred shots would be fired and the pistol would be allowed to cool for 5 minutes. After every 1000 rounds, the pistol would be cleaned and oiled. After firing those 6000 rounds, the pistol would be

tested with deformed cartridges, some seated too deeply, some not seated enough, etc. The gun would then be rusted in acid or submerged in sand and mud and some more tests would then be conducted.

During the trials, several alterations were made to the original design such as a single swinging link, an improved manual safety, and the inclusion of a grip safety and a slide stop. The other significant change was to the grips, which were angled more acutely and lengthened slightly.

In its final form, the 1911 was a locked-breech, single-action semi-automatic pistol. It was chambered for the .45 ACP cartridge and had a magazine capacity of seven rounds. Its weight unloaded was 39 ounces; overall length was 8.25"; the height was 5.25". Sights were fixed, although the rear sight was housed in a dovetail slot that allowed it to be drifted either left or right for windage adjustments. The pistols were finished in blue and fitted with checked wood stocks.

Browning's pistols passed the whole test series with flying colors. It was the first firearm to undergo such a test, firing continuously 6000 cartridges, a record broken only in 1917 when Browning's recoil-operated machine gun fired a 40000 rounds test.

The report of the evaluation committee (taken from "The .45 Automatic, An American Rifleman Reprint," published by the National Rifle Association of America) released on the 20th of March 1911 stated :

"Of the two pistols, the board was of the opinion that the Colt is superior, because it is more reliable, more enduring, more easily disassembled when there are broken parts to be replaced, and more accurate."

On March 29th, 1911, the Browning-designed, Colt-produced .45 Automatic pistol, was selected as the official sidearm of the Armed Forces of U.S.A., and named Model 1911.

When we entered the Great War, the U.S. government had purchased some 140,000 M1911 pistols from both Colt and Springfield Armory. The Armory tooled up in 1913 to make M1911s and help fill initial orders. Altogether some 31,000 M1911s were built at Springfield prior to the U.S. entry into World War I. To meet wartime requirements, they made 45,000 more, all in 1918.

Guns made for these production runs were all stamped UNITED STATES PROPERTY on the frame. The slide carried the inscription MODEL OF 1911 U.S. ARMY. Those arms for the Navy and Marine Corps were stamped MODEL OF 1911 U.S. NAVY or MODEL OF 1911 U.S.M.C. Production runs increased when the World War I started and continued to increase through 1918. By May 1918, it had increased to 1,000 per day. The summer months of 1918 saw an increase to 2,200 per day.

To meet the needs of our expanding armed forces, 1917 planners estimated that a total of 765,000 pistols would be required. The estimate was later revised upward, first to 1.3 million and then to 2.7 million.

Filling the projected needs meant that pistols would have to be made by contractors other than Colt. Thus orders were placed with Remington-UMC, Winchester, Burroughs Adding Machine Co., Lanston Monotype Machine Co., National Cash Register Co., A.J. Savage Munitions Co., Savage Arms Co., and two Canadian firms, Caron Borthers Mfg. Co., and North American Arms Co., Ltd. Of those firms, only Remington-UMC delivered any meaningful quantity (22,000 of 150,000 ordered). North American did make some pistols, but the total was probably less than 100.

A number of foreign companies or governments were licensed to manufacture the Colt-Brownings in a variety of calibers. It is interesting to note that Colts at one time were produced under the direction of the Nazi government. In 1915 the Norwegian government was licensed to manufacture the pistols. When

Nazi troops occupied Norway in World War II, they ordered the government arsenal to start production. The Nazi's planned to use the pistol to arm their occupying forces. However, only about 1,000 guns were produced in 1941 and 1942.

After World War I, the Army's Ordnance Department evaluated the Colt .45's combat performance. They recommended the following changes:

1. Wider front sight to develop "Partridge-type" of sights, allowing the shooter to quickly align both front and rear sights under various lighting conditions.
2. Longer hammer spur. Both changes 2 and 3 work together to prevent the web between the thumb and the forefinger being pinched between the hammer and the safety spur when the gun is fired.
3. Longer grip-safety spur.
4. Arched spring housing fills the shooter's hand and checkering backstrap provides a better grip.
5. Relief cuts in the frame around the trigger allowing easier access to the trigger.
6. Shorter trigger with knurled face to avoid the trigger finger from slipping.

These changes were put into production on June 15, 1926 as **AUTOMATIC PISTOL, CALIBER .45, MODEL OF 1911A1.**

World War II was a replay of the situation in 1917, but worse. Colt .45s were in demand, not only by the U.S. Armed Forces, but also by the military establishments of our major allies. Again, contractors other than Colt provided the balance of the 2.5 million .45s made during 1941 to 1945. In all, four contractors added their share to Colt's 480,000-pistol contribution. Remington-Rand produced 1.03 million. Ithaca turned out 370,000. Union Switch and signal Co. of Swissvale, Pa., received and filled an order for 55,000 M1911A1s. And Singer Sewing Machine contracted to provide 500 1911A1 pistols-which it did.

The pistol remained in service through World War II, the Korean War, and the War in Vietnam. The old war-horse proved to be particularly useful in the tunnel fighting that went on in Vietnam. For more info on the discernment of the various manufacturers of 1911 pistols during the war years, see the REC.GUNS FAQ.

The Norwegian 1911 (Model 1912 and 1914)

Colt .45 Autos have been copied, both here and abroad, almost since the first ones were made. The first of the foreign copiers was Norway. Seeking a suitable semi-automatic pistol, the Norwegian military decided on the M1911 as early as 1912. In 1913 and 1914, the Norwegians purchased 300 commercial .45s from Colt and then, having established that no Norwegian product was acceptable, began to negotiate for a license to build guns in Norway. Under an agreement signed in January, 1915, payment of 25,000 kroner bought the Norwegians a set of Colt's drawings and the right to make M1911 pistols at their Kongsberg Weapons Factory for as long, and in whatever quantity they desired.

Formally adopted as the "Colt Automatisk Pistol Model 1912," the first 500 guns are virtual twins of the Colt product, differing only in marking. The second production lot, begun in 1919, carried a different slide marking-11.25 m/m Auto. Pistol M/1914. The M/1914 also features a slide release lever that is distinctly different from those on both Colt and M/1912 Norwegian pistols.

The Kongsberg plant turned out about 20,000 M/1914 pistols between 1919 and the early '30s. Then, military demand satisfied, the line shut down. Under German occupation during World War II, the production of M/1914 was re-started, and another 10,000 were produced. Following the war, a few M/1914s were assembled from parts to bring the total made to just under 33,000.

- From *The .45 Automatic*, "Service Pistol Surrogates" by J.B. Roberts, Jr.

1911-A1 Modelo 1927

After adoption of the M1911A1 in the United States, the Argentine government purchased the pistol from Colt as the Model 1927. The order to Colt was for a run of 10,000 guns for the Argentine Army. These guns were serial numbered in their own range from 1 to 10000. The original finish of these guns was blued with a brush blue finish and they had checkered walnut grips. The way to recognize them is that on the right side of the slide it has the following markings:

EJERCITO ARGENTINO
Colt CAL. 45 MOD. 1927 S/N

In the 1930's, the Argentines secured license to manufacture their own .45s. These are called "Sistema Colt" to distinguish them from the actual Colt Modelo 1927. These Model 1927s were made by Fabrica Militar de Armas Portatiles "Domingo Matheu," in Rosario, Argentina. They are marked "F.M.A.P" or "D.G.F.M. (F.M.A.P)" on the left side of the slide and "Ejercito Argentino, Sist. Colt, cal. 11.25 m.m. MOD 1927" in two lines on the right. All Model 1927s bear the Argentine seal on the slide.

In addition to military production, the firm of Hispano Argentino Fabrica de Automoviles. SA (HAFDASA), manufactured an unlicensed copy of the Colt known as the "Ballister-Molina." Most features of the HAFDASA gun are taken directly from the Colt product. The trigger and trigger linkage differ, however, in that the trigger pivots, and the trigger extension is external. The Ballister-Molinas also lack the grip safety. The story that the Ballester-Molinas are made from steel from the German battleship Graf Spee is a delightful but false legend. Both the Model 1927 and the HAFDASA .45s are extremely well-made pistols.

Civilian Commercial Production by Colt

In the early 1930's, Colt offered a target version of the basic civilian Model 1911. This National Match pistol first appeared in 1933. These pistols differed from the standard grade because they incorporated a match barrel, checked trigger, checked arched grip, walnut stocks and the internal parts were hand honed. Also included on later versions were a ramped front sight and an adjustable rear sight. These models were marked "NATIONAL MATCH COLT Automatic Calibre .45" on the left side of the slide. During World War II, the National Match Model was discontinued, but resumed in 1957. This newer version was referred to as the "Gold Cup National Match."

The MKIV Series 70 Government Model Colt pistols were manufactured from 1970 to 1983 and have "70G" as a prefix in the serial numbers on the models made from 1970 to 1976. The models made from 1976 to 1980 have "G70" suffixes. Models made from 1979-1981 have "B70" suffixes and models made from 1981 to 1983 have "70B" prefixes. The Series 70 had, in addition to the Government model, a Series 70 Combat Commander, Series 70 Lightweight Commander, and Series 70 Combat Government. The Series 70 featured an accurizer barrel bushing for improved accuracy.

In 1983, Colt presented the MKIV Series 80 pistol. It was a single action with 5" barrel. It was offered with checkered walnut grips and rubber combat style grips. This model had a firing pin safety incorporated.

In 1985, the United States Armed Forces replaced the M1911 with the Beretta 92F to the everlasting consternation of 1911 devotees everywhere. There were several reasons for the switch. The U.S. was the only NATO country not using a 9mm as the standard issue sidearm and there was a desire to issue a pistol chambered for the ubiquitous 9mm for logistical reasons. The Marines in particular resisted the switch to the Beretta and only accepted delivery when ordered to do so by Congress. Many special forces units within the armed services still select 1911-pattern sidearms. In 1998 The FBI S.W.A.T. team adopted the Springfield 1911A1 as standard issue. Anecdotal evidence out of Desert Storm indicates that the Berettas jammed because of the fine sand in the desert and the Marines broke out the 1911's.

Today (1999) 1911-pattern pistols are produced by Colt, Springfield Armory, Kimber, Para-Ordnance, Wilson Combat, Les Baer, Ed Brown, Caspian, STI, Robar, Auto-Ordnance, Strayer-Voight, Charles Daley, IAI, Llama, and others. The 1911 is perhaps more popular today than any time in its long and illustrious career.

A lot of people believe that the 1911-pattern pistol is the greatest combat handgun ever built. I certainly wouldn't argue with them, although I am aware that some other good pistols have been designed since 1911. It remains one of the best fighting guns ever, even though the single action design has become something of a liability in this hoplophobic milieu in which we live. Rather than stoking the "best" argument which is truly endless and without resolution, I will say only that the 1911 occupies a very special place in the history of combat weaponry, and in the hearts of pistoleros everywhere. It was the 1911 in the hands of Cpl. York which brought down the German patrol, which downed the Zero for 2nd Lt. Bagget, and fought until dawn against overwhelming odds with Kouma, Basilone, and Schmid. It was the 1911 which lay under John Dillinger's pillow and dangled from the drunken hand of Machine Gun Kelley at his capture. This rich history coupled with the superb performance of the pistol is unique and will never be duplicated.

Credits and Bibliography

Curt Gentry, *John M. Browning: American Gunmaker* (1964).
Richard C. Roberts and Richard W. Sadler, "Browning Company" in *Ogden: Junction City* (1985).
J. B. Roberts, Jr., "Service Pistol Surrogates" *American Rifleman*, (March, 1980.)
John Caradimas, M1911 Web Site, <http://www.m1911.org>
Sam Lisker, The Colt Auto Web Site, <http://www.coltautos.com>
Dave Arnold, "The Colt 1911/1911A1," *Guns & Ammo: The Big Book of Surplus Firearms*, 1998.
Oliver de Gravelle, Model 1911A1.com WWII production of 1911A1's by Colt, Remington, Ithaca, and Union Switch.

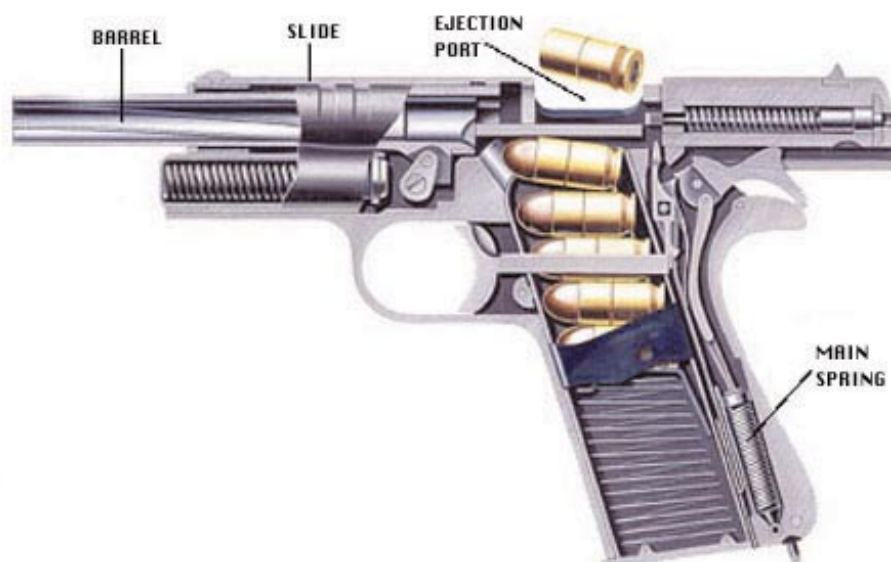



John M. Browning History

At the early age of seven, John Moses demonstrated an Interest in and aptitude for firearms-making by working in his father's shop, and at 14 he made his first rifle from scratch. Less than 10 years later in 1878, Browning completed his first rifle design for which he was awarded a patent (U.S. patent 220,271, 7 October 1879), By the time he married Rachel Teresa Child in the spring of 1879, he was a full-time gun maker, who between 1880 and 1882 with his brothers produced 600 single-shot rifles of the pattern patented by Browning. He sold the manufacturing and distribution rights to this rifle in 1883 to the Winchester Repeating Arms Company. John M. Browning's rise to fame as an arms designer began In earnest the day T. G. Bennett, vice president and general manager of Winchester, appeared in the doorway of his Ogden, Utah, shop and offered to buy his single-shot rifle. From this start grew the famous Winchester-Browning partnership that was to last for nineteen years. Winchester became one of the largest producers of sporting arms In the United States and almost all of Winchester's products were the work of John Browning.

When Winchester discontinued single-shot rifle production In 1920, they had manufactured over 140,325 units, including the 600 made in Ogden. From October 1884 through August 1886, Winchester also bought Browning's 1886 lever-action rifle and an 1887 lever-action shotgun, plus nine other designs, After serving his obligatory two years In the field as a Mormon missionary (March 1887 to March 1889), Browning returned to work on his guns, and over the next three years he patented twenty more designs.

John Browning's work with self-loading pistols was part of his general Interest in self-loading weapons. He started experimenting with self-loaders in 1889, six years after Hiram S. Maxim, when he converted a Winchester 1873 lever-action to a self-loading design by using the action of the gases at the muzzle. A machine gun using this same operating principle was built In 1890 and 1891. From this work evolved a machine gun design ultimately built and sold by Colt as the Model 1895 machine gun, popularly called the Browning potato digger because of its downward arcing, gas-operating piston system. Browning's first self-loading pistol was also a gas-operated weapon.

Browning's pistol looked conventional enough when the operating mechanism was closed, but when fired it could get exciting because the flapper-type gas piston mounted on the top of the barrel arced to the rear toward the shooter and momentarily blocked his line of sight. The reciprocating bolt was operated by a connecting rod that was attached to the gas piston lever. To load, the user grasped the head of the piston lever and swung it up and to the rear. This moved the bolt to the rear and cocked the hammer. Release of the lever permitted the bolt to go forward and strip a cartridge from the magazine. When fired, the projectile passed the gas port on the top side of the barrel after traveling 102 millimeters, and the gas actuated the piston lever.

Browning demonstrated his pistol on 3 July 1895 for John H. Hall and Carl J. Ehbets at the Colt factory in Hartford, Connecticut, and shortly thereafter the designer and Colt reached a verbal agreement giving Colt the production rights. In September, Browning applied for a patent (U.S. patent 580,923, 20 April 1897), and on 24 July 1896 he and Hall signed a formal agreement regarding this and three other pistols. In his contract with Colt, Browning gave the company distribution rights for his handguns in the United States only, as he planned to sell his pistols in Europe through another, yet unknown, manufacturer.

John Browning and Curt Gentry, John M. Browning, *American Gunmaker*. Ogden, Browning Co. 1964

Another Brief Bio

John M. Browning (1855-1926) was born in Ogden Utah. His parents were Mormons settling in Ogden only after they were driven out of Nauvoo, Illinois because of their religious beliefs. John M. Browning was one of twenty-two children. His father was a gunsmith and from him John learned the trade. The father never experienced the phenomenal success that was to visit the son.

T.G. Bennett, Vice President and general manager of Winchester Repeating Arms Co. travelled to Utah in 1883 looking for John Browning. One of the Browning designs for a big bore single shot rifle had impressed Bennett and the Winchester men; Bennett went West with the intent of purchasing the manufacturing rights to the rifle for the Winchester company. They paid Browning \$8,000 for it. Winchester first introduced the rifle in 1885. In 1886 John and his brother Matt went to New Haven with another prototype rifle. This became the famed Winchester model 1886, discontinued by Winchester in 1935. The rifle was modified in 1936 and became the Winchester model 71, discontinued in 1957.

During the 1890s Browning continued to sell prototype rifles to the Winchester Repeating Arms Co.. The Winchester model 92 (1892), discontinued in 1941. Browning designed the Winchester model 1894, which was the first repeating firearm capable of handling the higher pressures generated by the new smokeless powder. This gained fame as the "Winchester .30/30." Over 2.5 million of these rifles were produced and had not been discontinued as of 1962. Other Browning rifle designs purchased and sold by Winchester include the model 95 (1895).

Browning also sold shotgun designs to Winchester. Two of the most famous are the first "pump" action shotguns produced by Winchester. These were the model 1893 and the model 1897; the model 1893 was discontinued in 1897, the model '97 was discontinued in 1957. Between 1883 and 1900 Browning sold forty-four guns to Winchester.

For the most part, Browning designs dominated not only the Winchester line but the lines of other U.S. makers as well. He sold designs to Stevens, Remington, Colt, and Belgium's Fabrique Nationale. He is responsible for the Browning Automatic Rifle (BAR) the Colt Government model 1911 .45 caliber automatic pistol, and several other machine guns made by Colt. He was the first maker to develop the use of gas in the operation of machine guns and sporting arms. The Browning Automatic 5 autoloading shotgun was first patented in 1900 and is still in production. The Browning Arms company still bears the name and still produces his designs.



Browning Arms Company

The business known as the Browning Arms Company was officially organized in Ogden, Utah, under that name in 1927, a year after its most famous namesake, John Moses Browning, died. In actuality, the Browning organization had been around as early as Jonathan Browning's arrival in Utah and the establishment of his gun shop in Ogden in 1852. With the death of Jonathan, his son John Moses Browning became the head of the family's gunsmithing business, and with his brothers - Matthew, Jonathan Edmund, Thomas Samuel, William, and George - established in 1872 the Browning Brothers Company with its shop and retail store in Ogden.

John Moses Browning has been called "the greatest firearms inventor the world has ever known." His first patent was granted on 7 October 1879. He is credited with 128 gun patents, and some fifty million sports and military weapons were manufactured from those patents during the forty-seven years he was an active inventor. Among his most famous guns produced were the 45-caliber pistol; the 1895 Colt Peacemaker machine gun; the Browning automatic rifle; a variety of 30- and 50-caliber machine guns used in World War II; and the Browning Automatic-5 shotgun first made in 1902 and still produced today.

Browning Brothers manufactured guns in Ogden and produced 600 Browning single-shot rifles before the company turned over the patent to the Winchester Arms Company. From that time on, the company contracted with other arms manufacturing companies to produce its weapons. These companies included, in addition to Winchester Arms, the Colt Arms Manufacturing Company, the Fabrique Nationale of Belgium, the Remington Arms Company, and Savage Arms Company. All used numerous Browning patents, and it is not generally known that many of the guns produced by these companies were invented by John Browning.

In 1977 the Fabrique Nationale of Belgium purchased the Browning Company after a seventy-nine-year business association. The Browning Company still maintains its world headquarters in Mountain Green, Utah - located sixteen miles up the Weber River from the city of Ogden, where the Browning Museum at Ogden Union Station can be found. The company employs about 210 people at its Utah headquarters, which also includes research and some light manufacturing operations. Manufacturing is done in various factories in Belgium, Portugal, Italy, Japan, and Utah. Its sporting catalogs include rifles, shotguns, pistols, knives, fishing rods and reels, outdoor clothing, and golf equipment. In 1989 the company's sales volume in North America alone was in excess of one hundred million dollars.

See: Curt Gentry, *John M. Browning: American Gunmaker* (1964); Richard C. Roberts and Richard W. Sadler, "Browning Company" in *Ogden: Junction City* (1985).

Richard C. Roberts

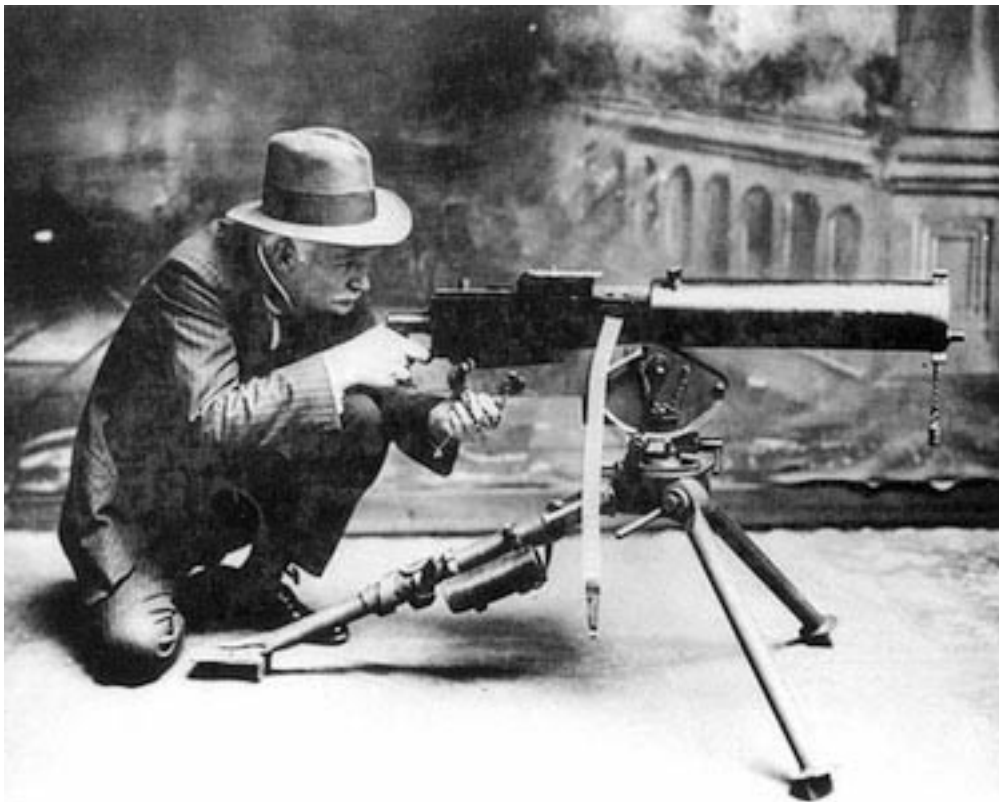

John M. Browning and his machine gun

Who made it?

by Robert Gibson (RGIBSON@ua1vm.ua.edu).

Several have posted over last couple of months asking how to ID the M1911A1 Govt 45 Auto, as in "I've got one, who made the darn thing?" Good question since the frame usually just says "GOVERNMENT MODEL" or "UNITED STATES PROPERTY M 1911 A1 U.S.ARMY"...or some such.

I'm certainly no Govt 45 expert but I dug up some info, maybe it will help, but first a bit of history.

World War I production: Four (4) manufacturers made M1911 pistols that actually saw use during the war years:

- * Colt
- * Remington-UMC
- * Springfield Armory (U.S. Government owned & operated)
- * North American Arms Co. of Quebec (just a VERY FEW)

Seven (7) manufacturers were tooling up to produce M1911 pistols but the Armistice stopped it all and program was cancelled:

- * National Cash Register Co.
- * Savage Arms Co.
- * Caron Bros. of Montreal
- * Burroughs Adding Machine Co.
- * Winchester Repeating Arms Co.
- * Lanston Monotype Co.
- * Savage Munitions Co.

World War II production: five (5) manufacturers made the M1911A1 pistol:

- * Colt
- * Ithaca
- * Remington-Rand
- * Union Switch & Signal
- * Singer Sewing Machine Co. (approx. 500)

The problem with ID'ing M1911A1's is that parts are totally interchangeable, and during the lives of many examples their slides were many times switched or replaced. Since the slide is the only part actually marked with the manufacturer's name, you can see the problem that arises.

The following taken from an article by Charles W. Karwan in the 3/1/95 issue of *Classic Firearms* will shed some light.

"All is not lost, however. The guns themselves can help you reveal which company made the pistol's frame. First, if you encounter an M1911A1 - identified by the finger cutouts and/or the M1911A1 markings on the frame - and it has a slide made by Remington-UMC, Springfield or Savage, you know the slide is not original to the gun since the first two manufacturers only made M1911 pistols during WWI, and the latter only made M1911 slides.

The slide is also not original if it has a drawing number on the side, usually 7790314. These are

replacement slides made long after WWII by Colt and SanColMar. The same is true if the slide is marked Drake - the company that built National Match slides for the government.

Looking at the pistol's frame, here are some rules to help you identify its maker:

1. The presence of VP proofmark in a triangle at the left front of the triggerguard; a GHD inspector marking or an M1911A1 marking without any spaces between the figures indicates an M1911A1 manufactured by Colt.
2. A serial number preceded by an "S" indicates an M1911A1 manufactured by Singer _(not many of these around - an understatement)_
3. A serial number preceded by a "NO" instead of a "No" indicates manufacture by Remington-Rand.
4. An RCD inspector mark or double spacing between the M and 1911A1 indicates manufacture by Union Switch and Signal.
5. A geometric-shape proofmark, like a triangle, arrowhead or such, on the front left of triggerguard indicates an M1911A1 made by Ithaca.
6. An "X" prefix to the serial number indicates a gun that has been re-serial numbered by ordnance, and the maker is neither identifiable or relevant.

These rules will not allow you to identify every single frame you encounter, but they will suffice for 99 percent of them."

BTW, when M1911A1 pistols were rebuilt at a military facility they were rebuilt without any regard to the maker of the frame, slide or other parts...mix 'n match, first in - last out, whatever was expedient to get the pistol in and out was the rule of thumb. Any such rebuilds will normally be stamped with a code indicating the facility that did the work. It might be any of the following (and there may have been others not shown):

- AAA - Anniston Army Depot
- AA - Augusta Arsenal
- OG - Ogden Arsenal
- MR - Mt. Rainier Ordnance Depot
- RA - Raritan Arsenal RR - Red River Arsenal
- RIA - Rock Island Arsenal
- SAA - San Antonio Arsenal
- SA - Springfield Armory
- BA - Benecia Arsenal

Anyway, hope some of this is of help to someone out there.

Robert Gibson





1911 Magazine FAQ

From: rawles@oro.net (James & Linda, Rawles)
Subject: M1911 Magazine FAQ (updated)
Date: 6 Mar 1998 00:19:29 -0500



Revised March, 1998

In response to repeated requests for clarification on the types and makers of M1911 series magazines during the World Wars and post-War, here is a brief outline:

“Two-tone” magazines. These are the type that were made up until just before WWII. They are called “two tone” because only the bottom half of the magazine was blued, while the upper half was left “in the white.” Most were made without lanyard loops. These sell for \$30 to \$70, depending on condition. Those with lanyard loops are much more scarce and therefore sell for \$50 to \$150, again depending on condition. There were several makers of two-tone magazines including:

Remington-UMC. Made by Remington during WWI to fill a large military contract. This is the most numerous type of two-tone you will find. These are unmarked, but can be identified by the short length of the floor plate tab that extends from the front of the bottom of the magazine. The tab is rounded, but much more steeply curved than that of the Colt made magazine described below.

Colt Mfg. Made by Colt before, during, and after WWI for both commercial sales and to fill military contracts. These too are unmarked, but can be identified by a longer and more smoothly rounded (a longer, less severe curve) floor plate tab than on the Remington contract magazines.

American Pin Company. Can be identified by a small letter A stamped on the TOP of the floor plate tab. Very Scarce.

Raymond Engineering. Can be identified by a small letter R stamped on the BOTTOM of the floor plate. Very Scarce.

World War II blued (a.k.a. “One-Tone”) magazines. Made in large quantities during WWII by a variety of contractors. Entire magazine body was blued. To my knowledge, none of the WWII types had lanyard loops. Prices range from \$10 to \$50, depending on maker and condition. Here is partial list of military contractors:

Colt. Can be identified by a small letter C stamped on the top of the floor plate tab, or “C-S” on the BOTTOM of the floor plate. There is some debate as to whether or not “C-S” stands for Colt-Scoville, i.e. a subcontract by Scoville for Colt.

General Shaver. Can be identified by a small letter G stamped on the top of the floor plate tab.

Little. Can be identified by a small letter L stamped on the top of the floor plate tab.

Risdon. Can be identified by a small letter R stamped on the TOP of the floor plate tab. Don't confuse these with Raymond Engineering contract magazines, which have the letter R stamped on the BOTTOM of the floor plate.

Scoville. Can be identified by a small letter S stamped on the top of the floor plate tab.

Variants of Risdon and Scoville are marked respectively: “C-R” or “C-S” on the BOTTOM of the floor plate. I have seen one reference that indicated that these magazines were made under subcontract to

Colt, to put in Colt's WWII production M1911 pistols. Presumably, the markings stand for "Colt-Risdon" and "Colt-Scoville."

A Special Note on WWII magazines: Many gun shop owners and gun show dealers are relatively ignorant about the "top of the floor plate tab" markings on WWII magazines. Most of course know the significance of two-tone magazines. However, they often have a box of magazines that they have accumulated over the years that they *assume* are all after-market. If you take the time to sort through them and look for markings on the *tops* of the floor plate tabs, you can go home with some original WWI magazines at a bargain price.

Post-WWII M1911 series .45 magazines:

Commercial Colt (pre-1970). Marked "Colt .45 Auto" on the bottom of the floor plate. Beware! Many of the after-market copies carry the same marking. However, the "counter" holes in the side of the magazine body are generally over-sized. The other dead give-away is the typeface ("font") used in the marking. It is not the same style font used by Colt, and the number "45" is usually not preceded by a decimal point.

Post WWII military contract. Most of these were made during the Vietnam "conflict". They can be identified by a lengthy military part number and manufacturer's contract number on the floor plate. These markings fill up most of the bottom of the floor plate.

Commercial Colt (post-1970.) Marked Colt .45 Auto on the bottom of the floor plate. A rampant stallion (a.k.a. "prancing pony") marking was added around 1970. Still in production. For many years the magazine bodies have been produced under subcontract by the Metalform Company for Colt. Shooting Star Company now produces some of the magazine followers for Colt—most notably these followers are used in the 8 round stainless steel model that was first produced for the now discontinued Double Eagle, but is now standard for all full sized Colt .45 autos.

After-market copies. Too numerous to list here. Most are total junk, and not worth buying. (You can expect horrible feeding problems.) In particular, beware of fake "Colt made" magazines! Three points to look for to determine if they aren't the genuine Colt-made item: 1) The fake magazines are marked "Colt 45 AUTO" but without a decimal before the "45". They may say "Colt" but they aren't made by Colt! 2) The typeface (font) is not the same as that used on genuine Colt magazines, and is much more deeply stamped. 3) The "counter" holes in the side of the magazine are often much larger than originals. Keep in mind that the lack of a "pony" doesn't necessarily mean that a magazine isn't a genuine Colt. The pony marking didn't begin until around 1970. The best evidence of originality is the type font used in the marking. (Compare side-by-side with a *known* Colt-made magazine until you learn to identify the original type font at a glance.)

Some exceptions to the "don't ever buy after-market" rule are .45 magazines made by **Metalform, Shooting Star, and Wilson-Rogers**. These are some of the *few* after-market brands that my customers report work well. There may be a few others that work, but why take the risk? In general, unless you want to buy grief, only buy original Colt made magazines, or original U.S. G.I. military contract magazines.

I hope that you find this information useful.

James Wesley, Rawles
Clearwater Trading Co.
c/o P.O. Box 642
Penn Valley, Calif. [95946]
voice: (530) 639-1999
e-mail: rawles@usa.net

"No man's life, liberty,
or property is safe
when the legislature
is in session."
- Judge Gideon J. Tucker

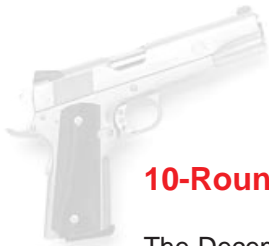

10-Round Magazine Tests

The December issue of Performance Shooter magazine has an article on a test they ran on 4 different makes of 10 round .45 mags for 1911 style pistols. The mags they tested were from Chip McCormick (\$23.95), Wilson Combat (\$31.95), Metalform (\$25.55), and Ed Brown (\$31.95).

All the magazines were purchased from Brownells, and they bought 4 mags of each type. They were tested "in a variety of guns and in the hands of several shooters for reliability, durability, ease of handling, and ease of maintenance."

They ended up not recommending the Chip McCormick ("It caused significantly more functioning problems than the others.") or the Wilson Combat mags ("had more than its share of problems"). They recommended the Metalform ("functioned better than the McCormick and Wilson units") and the Ed Brown ("performed flawlessly") mags.

They felt the reason the McCormick and Wilson mags suffered more failures was due to the shape of the follower. The McCormick has a flat follower, while the Wilson has a follower that is "black plastic and held the ammo in a round indentation". The followers on the Metalform and Ed Brown mags were rounded up.

Geoff Beneze Add-Ons

GSanford at cgsanford@mindspring.com on 2/2/98 2:02 AM wrote

> Meanwhile, I sure would like to hear you folks discuss what
> kind of internal parts I should get; barrel, trigger, hammer and sear,
> springs, etc.

This part could prove to be a lively debate! Overall, (IMO), the internal parts BRAND doesn't make any difference as long as they're from one of the "names". Each person will no doubt develop and affinity to a particular brand as you deal with various parts. I lean very heavily toward Wilson and McCormick. For no logical reason McCormick's triggers, hammers and sears appeal to me a great deal. However, I don't like their slide stop at all. I prefer Wilson beavertails, slide stops, magazine releases and hex head screws for the grips. I use the Cooper "High Grip" safety from Brownell's. I tend to use Wolff spring kits.

For sights, I normally choose either MMC adjustables (yes, even for carry guns) or Bomar BMCS-2, sometimes with the RPM ghost ring sight Bomar adaptor (this is what I carry daily) I like the bight puke green plastic inserts in my front sight (eyes getting old) and won't do a trigger job lighter than 4 lb commercially

I've used Brown and King parts in the past, but for no logical reason I can give, they just haven't/dont' appeal to me. This isn't to say that they're bad, since I can't say WHY they don't appeal.

IN grips and triggers (maybe hammer shapes too), I normally say to get what most turns you on since these items are the "racing stripes" of a 1911.

geoff beneze
geoffb@beast-enterprises.com

* BEAST Enterprises/Arizona Shooting Sports *
* <http://www.beast-enterprises.com> *
* BEAST gunsmithing, Target stands, Rifle Gongs *





The Conditions of Readiness:

Syd Weedon

The legendary guru of the combat 1911, Jeff Cooper, came up with the "Condition" system to define the state of readiness of the 1911-pattern pistol. The are:

Condition 1 - Also known as "cocked and locked," means a round is in the chamber, the hammer is cocked, and the manual thumb safety on the side of the frame is applied.

Condition 2 - A round is in the chamber and the hammer is down.

Condition 3 - The chamber is empty and hammer is down with a charged magazine in the gun.

People have added two additional states, **Conditions 0 and 4**, Condition 0 meaning a round is in the chamber, hammer cocked, and safety off, and Condition 4 referring to the condition in which the chamber is empty, hammer is down and no magazine is in the gun.

The mode of readiness preferred by the experts is Condition One. Generally speaking, Condition One offers the best balance of readiness and safety. Its biggest drawback is that it looks scary to people who don't understand the operation and safety features of the pistol.

Condition Two is problematic for several reasons, and is the source of more negligent discharges than the other conditions. When you rack the slide to chamber a round in the 1911, the hammer is cocked and the manual safety is off. There is no way to avoid this with the 1911 design. In order to lower the hammer, the trigger must be pulled and the hammer lowered slowly with the thumb onto the firing pin, the end of which is only a few millimeters away from the primer of a live round. Should the thumb slip, the hammer would drop and fire the gun. Not only would a round be launched in circumstances which would be at best embarrassing and possibly tragic, but also the thumb would be behind the slide as it cycled, resulting in serious injury to the hand. A second problem with this condition is that the true 1911A1 does not have a firing pin block and an impact on the hammer which is resting on the firing pin could conceivably cause the gun to go off, although actual instances of this are virtually nonexistent. Finally, in order to fire the gun, the hammer must be manually cocked, again with the thumb. In an emergency situation, this adds another opportunity for something to go wrong and slows the acquisition of the sight picture.

Condition Three adds a degree of "insurance" against an accidental discharge since there is no round in the chamber. To bring the gun into action from the holster, the pistol must be drawn and the slide racked as the pistol is brought to bear on the target. This draw is usually called "the Israeli draw" since it was taught by Israeli security and defense forces. Some of the real expert trainers can do an Israeli draw faster than most of us can do a simple draw, but for most of us, the Israeli draw adds a degree of complexity, an extra step, and an opening for mistakes in the process of getting the front sight onto the target.





Firing Pin Safety and Accidental Discharge from Dropping a 1911 From Geoff Benezé

Dillis Freeman at whiteknight71@yahoo.com on 5/23/98 7:34 PM wrote

>Actually, a firing pin safety protects you in various scenarios, such
>as if you drop the weapon on its muzzle, side, or rear with sufficient
>force to cause the sear or hammer to slip allowing the weapon to
>discharge in the absence of this safety. It also allows you to avoid
>the Rambo argument being used against you by showing that you
>intentionally bought a weapon with as many safeties as possible.

Ok, let's start working this myth over. It's apparently time for some more myth-busting.

Reading through Hatcher's Notebooks, one finds that he established primer detonation forces in the range of 12 in./oz. for "no fire" to the upper scale of 60 in./oz. for "all fire." This was for 30 cal. centerfire rifle ammo. We'll assume, for the sake of argument that there's no substantial difference between primers of various brands and sizes. The midpoint between the "all fire" and the "no fire" is 36 in./oz. I've just weighed a half dozen firing pins from my parts box and come up with an average of 65 grains, or .148 oz. If we have a free floating firing pin with no spring to impede forward movement, dropping the gun perpendicular on the muzzle from a height of 10 feet will generate almost 18 in./oz.

Again, assuming Hatcher's midpoint of 38 in./oz. would cause 50% of the rounds to fire we'd have to drop the gun, muzzle down, from a minimum of 20 feet. We're approaching Dean's figure of four stories here. Once we add the FP spring to the equation - and my (VERY) informal testing of spring weight indicates a rate of between 3 and 3.5 Lb. So we add 48 oz more to the 36 to overcome the spring and then set off 50% and we're getting into a drop range that's achieved only by mountain climbers and pilots. The same values hold true of falling on the hammer (if down).

The ONLY place where the Series 80 stuff actually would make a difference is 1. Feelin' Good, and 2. a mechanical malfunction/failure that allowed the hammer to drop.

As to the second statement, EVERY TIME we repeat such drivel, we give away some of our power (rights) to the anti's. EVERY SINGLE TIME we say it, we're damaging our cause. Until someone can show me case law where this was a factor, we'd all be better off if people pushing these bromides would just shut up.

geoff beneze, Tempe, AZ
geoffb@beast-enterprises.com



.45 ACP Reload Data from the Winchester Reloading Manual

| Handgun Data- 45 ACP | | | | | | | | | |
|-------------------------|-----------------|----------------|----------------|-----------------|----------------|----------------|-----------------|----------------|----------------|
| Bullet Wt. and Type | 231 | | | 540 | | | 571 | | |
| | Chg. Wt. (grs.) | Velocity (fps) | Pressure (psi) | Chg. Wt. (grs.) | Velocity (fps) | Pressure (psi) | Chg. Wt. (grs.) | Velocity (fps) | Pressure (psi) |
| 154 gr. Lead | - | - | - | 8.5 | 940 | 14,700 | - | - | - |
| | - | - | - | 9.6 | 1060 | 19,800 | - | - | - |
| 180 gr. Lead Cast SWC | 5.3 | 885 | 15,300 | 8.0 | 880 | 15,900 | - | - | - |
| | 6.3 | 1020 | 20,000 | 9.0 | 980 | 20,300 | - | - | - |
| 185 gr. JSWC | 5.1 | 760 | 13,300 | 8.0 | 825 | 15,700 | - | - | - |
| | 6.1 | 920 | 18,600 | 9.0 | 950 | 20,000 | - | - | - |
| 185 gr. JHP | 6.2 | 915 | 17,200 | 9.1 | 905 | 16,800 | 10.3 | 935 | 16,800 |
| | 6.8 | 990 | 19,500 | 10.0 | 1015 | 20,300 | 11.3 | 1045 | 19,400 |
| 200 gr. Lead Cast SWC | 4.8 | 800 | 14,900 | 7.2 | 805 | 15,600 | 8.5 | 835 | 15,300 |
| | 5.5 | 910 | 19,600 | 8.3 | 925 | 20,000 | 9.5 | 945 | 19,500 |
| 200 gr. FPJ | 5.4 | 815 | 16,200 | 8.1 | 825 | 16,600 | 9.2 | 850 | 15,600 |
| | 6.1 | 920 | 19,900 | 8.9 | 925 | 20,000 | 10.2 | 960 | 19,900 |
| 200 gr. JHP | 5.3 | 830 | 16,200 | 7.8 | 810 | 16,600 | 9.0 | 860 | 16,600 |
| | 5.8 | 905 | 19,500 | 8.5 | 895 | 19,900 | 9.8 | 945 | 20,000 |
| 230 gr. Lead Round Nose | 4.5 | 765 | 15,500 | 6.9 | 750 | 14,300 | 7.7 | 800 | 15,900 |
| | 5.1 | 870 | 19,800 | 7.6 | 860 | 19,700 | 8.7 | 890 | 19,800 |
| 230 gr. FMJ | 4.9 | 695 | 14,900 | 7.4 | 745 | 16,100 | - | - | - |
| | 5.7 | 830 | 19,200 | 8.1 | 830 | 19,800 | - | - | - |
| 230 gr. JHP | 4.8 | 740 | 18,000 | 6.9 | 715 | 17,200 | 8.4 | 795 | 18,400 |
| | 5.1 | 785 | 20,000 | 7.6 | 800 | 19,900 | 8.9 | 845 | 19,900 |



[Click Here to Download the Whole Winchester Reloader's Manual in *.PDF format](#)

| Handgun Data- 45 ACP | | | | | | | | | | | | |
|-------------------------|-----------------|----------------|----------------|-----------------|----------------|----------------|-----------------|----------------|----------------|-----------------|----------------|----------------|
| Bullet Wt. and Type | WST | | | WSL | | | WSF | | | WAP | | |
| | Chg. Wt. (grs.) | Velocity (fps) | Pressure (psi) | Chg. Wt. (grs.) | Velocity (fps) | Pressure (psi) | Chg. Wt. (grs.) | Velocity (fps) | Pressure (psi) | Chg. Wt. (grs.) | Velocity (fps) | Pressure (psi) |
| 154 gr. Lead | - | - | - | 5.5 | 940 | 14,800 | - | - | - | 8.2 | 1035 | 15,900 |
| | - | - | - | 6.4 | 1085 | 19,900 | - | - | - | 9.0 | 1135 | 19,700 |
| 180 gr. Lead Cast SWC | 4.6 | 880 | 16,200 | 5.0 | 865 | 14,800 | 6.6 | 960 | 15,900 | 7.5 | 940 | 14,900 |
| | 5.4 | 1000 | 20,000 | 5.9 | 990 | 19,800 | 7.4 | 1060 | 20,000 | 8.3 | 1055 | 20,000 |
| 185 gr. JSWC | 4.3 | 745 | 13,400 | 4.9 | 775 | 14,400 | 6.0 | 775 | 12,800 | 7.2 | 865 | 14,900 |
| | 5.3 | 890 | 19,000 | 5.9 | 935 | 20,000 | 7.0 | 950 | 17,600 | 8.1 | 1000 | 20,000 |
| 185 gr. JHP | 5.1 | 875 | 17,100 | 5.8 | 900 | 16,900 | 7.2 | 920 | 15,600 | 8.3 | 970 | 17,100 |
| | 5.6 | 935 | 19,800 | 6.5 | 980 | 19,700 | 7.9 | 1035 | 19,700 | 8.9 | 1045 | 19,900 |
| 200 gr. Lead Cast SWC | 4.4 | 830 | 15,400 | 4.3 | 755 | 13,700 | 6.0 | 870 | 15,200 | 6.6 | 850 | 14,900 |
| | 5.1 | 910 | 19,900 | 5.4 | 910 | 19,800 | 6.7 | 970 | 19,400 | 7.6 | 970 | 19,700 |
| 200 gr. FPJ | 4.7 | 825 | 16,400 | 5.0 | 790 | 15,600 | 6.5 | 870 | 15,500 | 7.0 | 825 | 15,000 |
| | 5.3 | 890 | 20,000 | 5.9 | 920 | 20,100 | 7.3 | 980 | 19,400 | 8.0 | 965 | 19,400 |
| 200 gr. JHP | 4.7 | 820 | 16,900 | 4.7 | 770 | 15,500 | 6.6 | 870 | 15,500 | 7.0 | 855 | 15,200 |
| | 5.2 | 885 | 19,900 | 5.4 | 875 | 19,600 | 7.1 | 970 | 19,500 | 7.7 | 965 | 20,100 |
| 230 gr. Lead Round Nose | 4.0 | 750 | 16,200 | 4.2 | 745 | 15,100 | 5.5 | 820 | 15,200 | 6.6 | 845 | 16,600 |
| | 4.5 | 805 | 20,100 | 4.8 | 840 | 19,800 | 6.2 | 910 | 19,600 | 7.3 | 915 | 19,600 |
| 230 gr. FMJ | 4.1 | 710 | 15,500 | 4.7 | 735 | 15,900 | 5.7 | 755 | 14,900 | 6.8 | 820 | 16,800 |
| | 4.9 | 800 | 19,900 | 5.3 | 835 | 19,800 | 6.6 | 885 | 19,200 | 7.4 | 885 | 19,600 |
| 230 gr. JHP | - | - | - | 4.4 | 705 | 16,800 | 5.7 | 780 | 16,500 | 6.1 | 760 | 16,200 |
| | - | - | - | 4.8 | 770 | 19,900 | 6.1 | 850 | 19,600 | 6.6 | 835 | 20,200 |





The .45 ACP

When you take a look at the large missile-shaped cartridge of your average deer rifle, and better yet, when you put the rifle to your shoulder and fire it, a little alarm ought to go off in your head about pistol cartridges--all pistol cartridges. They are all inadequate in terms of real power. I like Clint Smith's definition that "a pistol is something you use to fight your way back to your gun." Pistols have their place due to the ease with which they can be carried and brought into action, but it's important to recognize their limitations. Notice that no fighting force in history has gone into battle armed with pistols as their primary weapons.

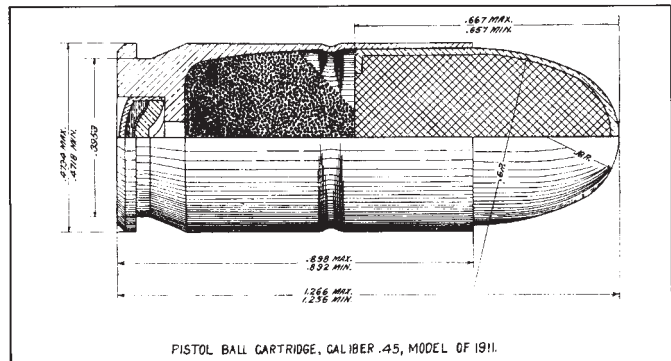

The drawing above, from a 1918 "Manual of the Automatic Pistol Caliber .45 Model of 1911," illustrates components of the original military .45 ACP loading—a 230-gr. bullet traveling at 855 f.p.s.

Some pistol cartridges are less inadequate than others, and one which comes pretty close to adequate is the .45 ACP. "ACP" stands for "Automatic Colt Pistol."

John Browning is credited with having designed the .45 ACP cartridge. Browning's .45 ACP was built specifically for the pistol that many of us regard as one of the greatest pistol designs ever, the M1911. However, I'm not at all sure that the M1911 wouldn't have been chambered for .38 Super had Browning been left to his own devices.

The man who pushed the Army into adopting the .45 caliber cartridge was Gen. John T. Thompson, the father of the Thompson submachine gun and a member of the Army Ordnance Board during the time that the M1911 pistol was being developed by John Browning and Colt. After the disastrous showing of the Army's .38 Long Colt pistols in the Philippines, Gen. Thompson was committed to the idea that the Army should be packing a real man-stopper in its handguns, a big .45 caliber bullet.

It was the cartridge tests conducted by Thompson and Major Louis Anatole LaGarde of the Medical Corps in 1904 at the Nelson Morris Company Union Stockyards in Chicago that resulted in the adoption of the .45 caliber as the official U.S. Army handgun cartridge. They tested various calibers on live cattle, deer, and human cadavers to determine the best load. From these tests it was determined that the .45 was the most effective cartridge for a handgun, but with reservations. In their report, they state:

"the Board was of the opinion that a bullet, which will have the shock effect and stopping effect at short ranges necessary for a military pistol or revolver, should have a caliber not less than .45". But they also said, "...soldiers armed with pistols or revolvers should be drilled unremittingly in the accuracy of fire" because most of the human body offered "no hope of stopping an adversary by shock or other immediate results when hit."

In response to the Ordnance Board's specification, Browning designed the .45 ACP for the pistol he was submitting to the board. Browning's first loading was a 200 grain bullet running at 900 feet per second, but the Army wanted a larger bullet. Browning responded with the loading we have today, a 230 grain bullet with a muzzle velocity of 850 feet per second.

Stopping Power

It is interesting to observe that we still argue this basic question of terminal ballistics which was articulated by Thompson in 1904. The tag-team wrestling match in the terminal ballistics field is currently

between Ed Sanow and Evan Marshall in the "small and fast" corner, and Dr. Martin Fackler (backed up by Thompson and LaGarde) in the "big and slow" corner. This discussion quickly degenerates into a lot of arcane mumbles about temporary and permanent crush cavities, energy transfer, hydrostatic shock, and the Miami FBI shoot-out. It's interesting if you're a physicist or a forensic pathologist, but it gets kind of academic for the rest of us. "Small and fast" works really well with high-powered rifles when their small 80 grain bullets are traveling at 4000 feet per second, but hand gun cartridges don't operate at those energy levels. The best of the small and fast pistol rounds is the 125 grain .357 Magnum which has enjoyed an impressive service record in the "one shot stop" statistics. It has also suffered some spectacular failures in which the bad guy was shot multiple times center of mass and remained on his feet.

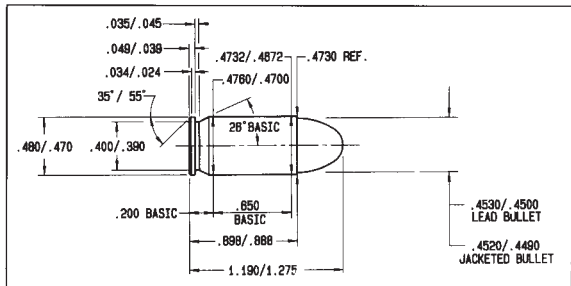

Reloading manual drawing for the .45 ACP reveals crucial case and overall dimensions necessary to produce safe, accurate handloads for this tried-and-true, rimless-design autopistol cartridge.

Evan Marshall and Ed Sanow have worked up a set of statistics based on results of actual shootings in which one shot was fired into the torso of the attacker stopping the assault, and from these studies they have developed percentage ratings for "one shot stops" for cartridges from .22 to 12 gauge. The Marshall and Sanow numbers show a tendency for small and fast cartridges to do somewhat better than large and slow ones, i.e., .380's do slightly better than .38 Specials from 2" barrels and .357 Magnums do a percentage or so better than the .45 ACP. You

can read the summary of their study and statistics on Dale Trowert's Stopping Power Page. Understand that controversy still rages about the Marshall and Sanow study, particularly about their methods, sources of data, and the shootings they chose to exclude. Nevertheless, it's an interesting study.

Jim Higgenbotham, a 30-year law enforcement veteran and trainer writes the following on the subject of pistol cartridges and failures to stop:

"While I have come across some lethal encounters that took a lot of rounds to settle they mostly were the result of either poor hits (or complete misses) or lack of penetration. Nearly all of the high round count cases I have reviewed involved 9mms, .38s, .357's or smaller calibers. This is not to say they do not occur with major caliber rounds. It is to say I have been collecting data for 30 years and have not encountered many cases in which multiple hits (more than three as two or three shots are a fairly normal reflex action) from major caliber cartridges to the center of the chest have not been sufficient, - the single exception being a case involving the .41 Magnum loaded with JSP bullets which did not expand - they did penetrate - it took five hits center mass to stop the attacker - and I have not encountered any with the .45, even with Ball. I have encountered several with 5, 6 or even more hits to the center of the chest with .38, .357, 9mm and .223 rifle rounds failing to stop. Almost every one could be traced to lack of penetration with a couple of exceptions that hit the heart but just did not cause enough damage to be effective quickly. Note I am not talking about "torso" hits. There is a lot of area in the torso in which a hit will seldom produce rapid incapacitation even if hit by a 12 ga. slug or a 30-06 - we simply cannot count such data if we are going to learn anything."

My purpose here is not to argue Fackler versus Marshall and Sanow because that's a book in itself. What is important in all of this is that regardless of which philosophy you choose to accept as true, the .45 ACP comes out well--at or near the top of the effectiveness ratings for both schools of thought.

Having established the almost universal agreement that the .45 ACP is an acceptable personal defense cartridge (kind of like proving the ocean is wet), are there negatives? Sure there are. For one thing, the .45 ACP is big and heavy. The same characteristic that makes it so admired by the big hole school also

makes it heavy to carry and bulky, resulting in fewer rounds being available in compact handguns. A fully loaded Thompson submachine gun is fairly heavy if you have to lug it around through a hot jungle all day. Some people find the recoil of the .45 ACP punishing although I'm not one of them (I actually prefer the recoil of the .45 ACP over the recoil of the 9mm). The penetration of the .45 ACP 230-grain FMJ bullet is 26" in ballistic gelatin, making it problematic and dangerous as a personal defense load. The threat of over-penetration with the military round necessitates the use of hollow points for LEO and civilian PDW applications. Some of the older 1911 pistols don't like hollow point bullets very well and have to be throated and have their feed ramps polished for reliability. And last, there is the cost. The .45 ACP is expensive as pistol cartridges go, often \$3-\$4 per box more than 9mm or .38 Special.

The specs and behavior of this cartridge are central to its success. Even people who don't like the 1911-pattern pistol often seek other systems to launch the .45 ACP and every major gun maker builds pistols around the cartridge. Smith and Wesson even builds a revolver for it.

Specs for the .45 ACP

| Dimensions | Minimum | Maximum |
|-----------------|---------|--------------------------|
| Overall Length | 1.256" | 1.266" |
| Bullet Length | .657" | .667" |
| Bullet Diameter | .451" | .451" |
| Case Head | .4718" | .4734" |
| Case Mouth | .4672" | .4732" (.4730" standard) |
| Case Length | .892" | .898" |

| Ballistics | |
|-----------------------|------------------------|
| Bullet Weight | 230 grain (14.9 grams) |
| Bullet Type | FMJ |
| Ballistic Coefficient | .195 |
| Muzzle Velocity | 850 feet per second |
| Energy at 25 yards | 350 foot-pounds |
| Effective Range | 100 yards |
| Mid-Range Trajectory | 1.6 @ 50 yards |

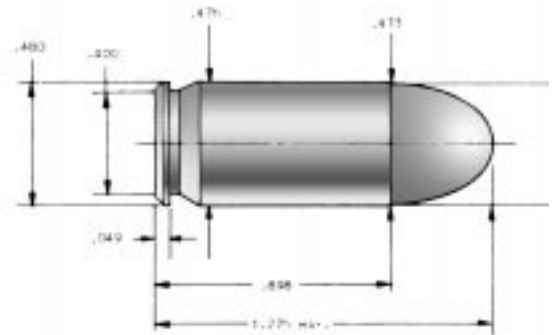

One of the goals of my life to which I am committed to making a reality is to render all of this ballistic speculation academic by never having to shoot anybody. Much of my time with a handgun is spent doing fun stuff like target shooting and IDPA matches. The .45 is a fun gun and cartridge to shoot. It's hard for me to imagine myself shooting a match with a DA/SA "crunchenticker" (as Col. Cooper likes to call them). I could if I had to, but I don't have to so I don't.

You often hear it said that the 1911-pattern .45 ACP is "an easy gun to shoot well." Experience and the testimony of generations of shooters bears this out. Although this ease in doing well is generally attributed to the properties of the pistol, particularly the trigger, it's my opinion that the .45 ACP cartridge contributes to the superlative performance of the handgun. The .45 ACP 230g FMJ is possessed of great inherent accuracy. With the excellent trigger and this load, you can shoot ragged holes all day.



Pet Loads for the 1911

(Editor's Note and Warning: Always start testing a new load at **10% below** the recipe and work up, checking fired brass for signs of excessive pressure such as bulges around the head and cratered or blown-out primers.)

From **Bill Wilson** in *Wilson Combat 1911 Auto Maintenance Manual*

It's critical that you feed your 1911 pistol good ammo if you are to obtain maximum reliability. The load that I've shot the most over the past 19 years is - .45 ACP, 5.0 gr Hercules Bullseye, 200 gr. H&G #68 L-SWC (sized .452"), and primer (I use Winchester), OAL 1.250", Taper Crimp .469" at case mouth, primers .002" below flush. This load has proven to be accurate and reliable in any pistol I've tried it in.

More recently, I've been shooting a lot of Hodgdon Clays powder because it's so clean burning, about 4.7-4.8 usually makes major power factor.

For hollow point loads, I've had best results with Hornady XTP bullets. Both the 200 gr. and 230 gr. have been extremely accurate and perform well on hogs and deer. I load the 200 gr. to 950-1025 FPS using Royal Scot "D" and the 230 gr. To 875-950 FPS also with Royal Scot "D" because of its low muzzle flash. OAL should be 1.225".

If you don't hand load, I'd recommend any of the promotional ball ammo such as Winchester Q loads, Federal American Eagle, Remington UMC. For serious work, I prefer Federal 230 gr. Hydra-Shok and Cor Bon 230 gr.

The proper recoil spring for your particular pistol/load combination is the heaviest recoil spring you can use that will still allow the pistol to reliably lock open after the last shot when held loosely in one hand.

From: "**L. Mo**" <ldmo@earthlink.net>
Newsgroups: rec.guns
Subject: Re: Loads - New FBI .45

Dick,

I have a friend who is FBI SWAT & the rounds they use for their SIG 9mm's, Springfield .45's & MP5 10mm's are Remington Golden Saber. The .45's are the 230 grain bullets.

Laurence

From: "**Michael Orick**" <brokenarrows@worldnet.att.net>
To: "1911-L" <1911-l@scifi.squawk.com>
Subject: [1911-l] "Best" 45 Load?
Date: Wed, 7 Oct 1998 09:44:50 -0600



If expansion is what you are after, the Remington 185 +P (not the GS +P) expanded to .81 caliber and penetrated 9.5 inches in the FBI heavy clothing test (from a SIG P220).

The 230 GS did .73/.18.85 if you need to drill for oil.

Some others (all from 5 inch guns):

| | |
|--------------------|-----------|
| Fed PDA 165 | .75/11.0 |
| Speer 185 | .68/14.75 |
| Federal 185 | .61/19.8 |
| Win ST 185 | .73/10.9 |
| Speer 200 | .45/23.45 |
| Fed 230 HS | .66/16.35 |
| Win 230 | .51/24 |
| Win 230 Ranger SXT | .63/17.8 |
| Win 230 BT | .74/13.95 |



Check out Firearms Tactical Institute website for more info (www.firearmstactical.com) .

Mike >>>>————>

From: MAMBA9@aol.com
Date: Thu, 8 Oct 1998 13:09:56 EDT
To: 1911-l@scifi.squawk.com
Subject: Re: [1911-l] 45ACP pet loads

>>Does anyone have a pet load they would like to share with me?

4.3 gr of Win Super Target and 230 lead will make the mildest major load around. Real clean, real accurate in all my guns.

From: "Jon Diller" <jon@mail.idinet.com>
To: <1911-l@scifi.squawk.com>
Subject: RE: [1911-l] 45ACP pet loads
Date: Thu, 8 Oct 1998 12:57:31 -0500

5.7 to 5.9 gr of WST under a 200 gr H&G68 pattern LSWC. 875 fps with 5.7, 975 with 5.9. 5.9 seems to be more accurate but beat hell out of my gun.

Date: Thu, 08 Oct 1998 15:16:22
To: 1911-l@scifi.squawk.com
From: [cxm <cwm@metronet.com>](mailto:cxm@cwm@metronet.com)
Subject: Re: [1911-l] 45ACP pet loads

IMHO, Bullseye is tough to beat..... it is VERY accurate, it's economical though it is a bit dirtier than some other powders. In terms of economy, it is the best.... I use it for the majority of my pistol loads (in 9mm, 38spl. and .45 target loads.)

I'm currently using Hogdons Clays for my .45 IDPA loads, BUT will drop it as soon as my current supply is exhausted. Clays is relatively clean burning. It is not well adapted to smaller capacity cartridges. I have used Unique for my higher end .45 loads for years and years, and will go back to it when the Clays is gone. Neither of these powders are as economical as Bullseye. Winchester 231 is fairly economical as well, and gives good accuracy.

FWIW
Chuck

Date: Thu, 08 Oct 1998 16:50:00 -0400
To: 1911-l@scifi.squawk.com
From: Syd <sydw@sydwdn.win.net>
Subject: Re: [1911-l] 45ACP pet loads

>Does anyone have a pet load they would like to share with me?

My regular is 5.6g of Win 231 with 230g FMJ

Syd

Date: Tue, 6 Oct 1998 09:59:58 -0700 (PDT)
From: "J. Viray" <jviray@ncal.verio.com>
To: "1911 Mailing List (E-mail)" <1911-l@scifi.squawk.com>
Subject: Re: [1911-l] Best Round in 45

On Tue, 6 Oct 1998, Devlin Griggs [MTN - Alice Lane] wrote:

> A quick question for you, maybe you can make some suggestions. I carry a 45
> calibre handgun and use Winchester SXT's as a standard carry load (hollow
> point). Upon doing some tests at the range I found that about 50% of the
> rounds fired get "clogged" up and don't expand as they should. Could anyone
> give me some advice on a better round. (Hydro shock ???) Also, what is the
> benefit of a pre-fragmenting round compared to conventional one???

With a 50% "failure" rate, it sounds like for that given projectile you have inadequate velocity to assure expansion.

What kind of gun are you using? Something with a short barrel?

The SXT round probably performs similarly to most of the other premium quality 230gr JHP offerings. They're all designed to expand without fragmenting within a certain range of velocities. A different brand might or might not give you better results in your gun.

You might consider trying a 200gr or 185gr load, or even a "+P" load in 230, 200, or 185gr.

If expansion is really, really important to you, your best bet (based on gelatin tests) is probably going to be the Winchester Silvertip 185gr JHP or perhaps something like a Cor-Bon or Triton +P 185gr JHP. Note that you'll have (in general) significantly less penetration than you will from a 230gr JHP.

If you want to stick with 230gr JHP loads, the Federal Hydra-Shok is probably a good bet (with that little "post" in the cavity).





Glock vs. 1911

Glock fans seem obsessed with comparing their pistols to the 1911, with the overall thrust of the argument being an attempt to prove that the Glock is superior to the 1911 in every way. They will most often point to reliability, durability, capacity, weight, and the simplicity of the Glock design to demonstrate the point. My biases are as follows: I'm a 1911 fanatic and I'm not wild about Glocks. But is the Glock superior to the 1911? The two systems are so different that I have questions about the validity of any comparison beyond the fact that they're both pistols and choices need to be made. Here are some areas of comparison which lead me to prefer the 1911-pattern guns:

Reliability - I have seen more feed failures on 1911-pattern guns than I have with Glocks (or Smith & Wessons and Berettas, for that matter). My personal 1911's, a Springfield and a Kimber, don't experience feed failures, although the Springfield did have a couple when it was new. At a recent IDPA match, I witnessed a Les Baer Custom and Colt Gold Cup experience failure to feed. The original mil-spec 1911A1 is a very reliable gun when using the mil-spec ammo around which it was designed, and contemporary 1911's which are properly throated and broken in are also extremely reliable. The



original 1911's which were issued to the Army were built with very liberal tolerances—you could call them loose—because the Army valued reliability under adverse conditions above pinpoint accuracy. Many of the feed reliability problems with 1911 pistols arise from efforts to tighten up the frame, slide, barrel and bushing in order to achieve "match grade" accuracy. Glocks don't tend to suffer feed failures, but in order to achieve this reliability, they have more of their chambers cut away, leaving more of the case unsupported. This design feature has led to some blown Glock .40 S&W

pistols. One reliability issue which I've seen more with Glocks than other pistols is their occasional failure to detonate primers. While Glock advocates will say that other pistols have the same problem, I've only seen it happen on Glocks. While Glock true-believers are driven to proclaim their guns as the ultimate in reliability, the NYPD has been experiencing extractor problems and double feeds on their Glock 9mms.



The Eye of the Beholder - I am one of those people for whom the appearance of a gun matters. I like beautiful guns made of high grade metals with fine finishes. I don't like black plastic. To me, the Glock is one of the ugliest designs every conceived by the mind of man. Although some custom finishes can be applied to the slide, the options for dressing up the Glock are very limited. In contrast, 1911-pattern guns can accept a wide variety of finishes, grip panels, custom components, engraving, and other modifications which enhance the appearance of the gun. Glocks are made by one manufacturer whereas 1911-pattern guns have been made by scores of manufacturers since World War I, adding a great deal of interest, variety, and individuality to the type.

Uniformity vs. Individuality - With 1911's you deal with a particular gun, the one you're holding at that moment. Glocks are, for the most part, homogenous within model types. Each 1911 has a personality of its own, even among examples of the same model and production run from the same manufacturer. Whether this annoys or delights is a matter of personal preference. Those who like personality and individuality in a pistol will find the Glock uninteresting, and those who value absolute consistency will find their confidence undermined by a fussy 1911 which refuses to feed their favorite load.

Durability - I have heard claims that Glocks have launched as many as 300,000 rounds from a single pistol without a failure. I've never seen any documentation which would substantiate these claims, and I

remain a bit skeptical about it. I'd like to see the gun, the round, and the test conditions. The FBI tests did document 50,000 rounds through the Glock .40 S&W without a breakdown, and that's an impressive performance. The original Army endurance test for the 1911 was 6,000 rounds. A well-built 1911 can be expected to have a service life of 150,000 rounds, although a part may break here or there during its lifetime. Only time will tell if the first Glocks will still be serviceable seventy five years from now; we know that many of the early 1911's are still functional and greatly desired by collectors.

Accuracy - In my opinion, an average government model 1911 is likely to be more accurate than the best Glock. In addition to that, 1911's can be tuned for greater accuracy whereas the Glock can't be. Between a really outstanding match grade 1911 and a Glock there is no contest in terms of accuracy. Glocks have acceptable accuracy for their intended mission, that being close range combat, but they are not tack-drivers. I haven't had opportunity to test one of the new long slide Glocks, but my initial impression is that they are an answer in search of a question.

Trigger - The one thing the Glock and the 1911 have in common is that their triggers are their greatest strength and weakness. The "revolutionary" design of the Glock centers on the trigger, the so-called "Safe Action Trigger." The Glock pre-cocks with the cycling of the slide so it can have a much lighter trigger than a true double action gun. In order to increase safety, the Glock was given a very long trigger pull and a little safety flange on the trigger which supposedly functions as a safety—if it isn't depressed the gun won't go off. But given the fact that it's on the trigger, it strikes me as largely superfluous. Aside from this, there are no external safeties on the Glock. If the trigger is pulled, the gun will go off, period. Personally, I find the Glock "Safe Action" scary, and lacking in the backup safety features that I prefer to see on an autoloader. Fans of the "Safe Action" point to the fact that there are no levers with which to fumble in a crisis and compare the Glock to a double action revolver (although very few revolvers have 5 lb. double action triggers). For a combat gun, these are valid points—simplicity translates into speed and keeps Murphy at bay, and light triggers give greater accuracy. However, the Louisville, KY police department switched to Glock .40's recently, and have already suffered four unintentional discharges by officers in two months.

The single action trigger of the 1911 is light, crisp, and short. Since little muscle action is required to break the trigger, trigger control is less of a problem on the 1911 than any double action or "Safe Action" system. Since the trigger pull is so short, rapid fire is easy and fast. And then there's the dark side: for a single action 1911 to be ready for action, it must be carried "cocked and locked," which means hammer cocked and manual safety on. More than anything else, this looks scary. People have come up with several strategies to avoid the cock and lock, also known as "condition one." There is the "Israeli Draw" which means the pistol is carried with an empty chamber and charged magazine ("condition three"), and is drawn and the slide racked as the gun comes up to fire. Some choose to carry with the hammer down with a round in the chamber (condition two). Condition two is just a bad idea for several reasons, but all of them have to do with the gun going off when you don't expect it to. Some choose simply not to carry the 1911 at all due to their discomfort with condition one.

My own preference is for the 1911 trigger with its double safety system (manual thumb safety and grip safety). Even if one were to forget to apply the manual safety, the grip safety must be depressed and the trigger pulled for the gun to fire. With that said, the 1911 requires training and practice to be a safe and effective personal defense weapon. The Glock trigger seems long and mushy, and since there are no external safeties other than the trigger flange, it strikes me as being more prone to accidental discharge than the 1911. For target and competitive shooting, the 1911 trigger is my favorite.

Weight and Capacity - In this category, the Glock has the clear advantage. The Glock with its polymer frame is lighter and uses double stack magazines. Even the compact Glock 30 carries 10 rounds in its magazine. Compact 1911's such as the Colt Officer's model and the Kimber Compact can carry seven in the magazine. Government models can carry eight rounds or ten with an aftermarket magazine which extends beyond the base of the grip. A number of manufacturers such as Para-Ordnance, Springfield, and Kimber have introduced "widebody" 1911-pattern guns which can accept 10-14 round double stack

magazines. To me, a true 1911 is a single stack gun. One of the strongest features of the 1911 is that wonderful, single stack grip.

Touchy-Feely - One of the greatest features of the 1911 is the narrow grip and short trigger configuration of the pistol. The grip of the 1911 remains the best feeling grip of any pistol I know of. The narrowness of the handle allows the hand to really wrap around the pistol and get a solid grip. The narrowness also benefits those with smaller hands, since the grip is narrow and the trigger relatively close to the handle. Also, within the configuration is a design feature which has been copied by the builders of most autoloaders since—the magazine release button located where the trigger guard meets the handle. Last, but very important, is the overall narrowness of the 1911 pistol which allows even the relatively large government model to be surprisingly easy to conceal. By way of contrast, Glock handles tend to be fat since they use double-stack magazine, and are more difficult to conceal due to their width. To me, a 1911 feels like a pistol ought to feel, whereas the Glock feels like a water gun.

Conclusion - Well, I warned you of my biases up front. Give me a 1911 any day.





Legends of the 1911

Sgt. Alvin York

On the morning of 8 October 1918, elements of the 328th Infantry, 82nd Division, United States Army, were pinned down by German machine-gun fire. Seventeen men, under the command of Sgt. Bernard Early, were ordered to out-flank the machine guns.

Shortly after they left their own lines, they came across a German officer and several soldiers having breakfast. Believing that they were surrounded, the Germans surrendered. However, before Early could detach a man to take the prisoners back through the lines, intensive machine gun fire swept the patrol. Eight American soldiers survived. Sgt. Early was killed. As the remaining non-com, Cpl. Alvin York took command of the patrol. While the remaining Americans covered their prisoners, trying at the same time to avoid enemy fire, York spotted the location of the German guns, about 30 yards away. In addition to his Enfield rifle, he also carried a Colt .45 automatic pistol. The German gunners peeked over the tops of their Maxim guns to avoid hitting their own men.

With the appearance of each face, framed in its "coal-scuttle" helmet, York's Enfield spoke. One shot equaled one dead gunner. York was from the Tennessee mountains where firearms were used to put food on the table. Mountain folk were frugal, making each shot count.

Unnoticed by York, several Germans moved forward, locating York's position. Out of sight, they counted the shots from York's rifle, establishing the pattern of his shooting. They counted a series of 5 shots from his Springfield and rushed York to gain the advantage of the few extra seconds it took to reload the rifle. As the Germans charged, they came into easy pistol range. York brought the .45 automatic into action, stopping the patrol in its tracks. He continued shooting and advancing, killing a total of 25 German soldiers and capturing 132 by himself. York was promoted to Sergeant and awarded the Congressional Medal of Honor.

Second Lieutenant Frank Luke, Jr.

On 29 September 1918, Second Lieutenant Frank Luke, Jr., of the United States Army's 27th Aero Squadron, flew over an American balloon squadron dropping a note, "Watch for burning (German) balloons" just beyond the German lines. As predicted, observers saw the three explosions of three balloons. Luke did not return. It was not until after the war that a grave's registration unit learned the conclusion of Luke's "3-kill" attack.

After destroying the third balloon, Luke was wounded and his Spad was so shot-up that he could barely control it. Nevertheless, he maneuvered his airplane to strafe German infantry columns. He crash-landed and was immediately surrounded by Germans. Rather than surrender, he drew his .45 automatic pistol and started firing at the Germans. They returned his fire, killing Luke immediately. Frank Luke was awarded the Congressional Medal of Honor posthumously.

Billy M.

In the town in Texas where I was born, they tell the story of a deputy named Billy M. who had recently returned from a combat tour in the South Pacific with the Marines. He was escorting a prisoner from the courthouse to the jail when the prisoner, who was in handcuffs, knocked Billy to the ground and dived onto the prone deputy with the intent of braining him with the handcuffs. Billy twisted around, drew his Colt Government and fired. It is said that the round lifted the prisoner up in the air, and he was quite dead by the time he hit the ground. My dad was a police officer for a while and served with Billy, so the tale comes from fairly reliable sources.



Earnest R. Kouma, MSG

U.S. Army, Co. A, 72d Tank Battalion.
Vicinity of Agok, Korea, 31 August & Sept 1 1950.

Citation: Sgt. Kouma, a tank commander in Co. A distinguished himself by conspicuous gallantry and intrepidity at the risk of his life above and beyond the call of duty in action against the enemy. His unit was engaged in supporting infantry elements on the Naktong River Front. Near midnight on 31 August, a hostile force estimated at 500 crossed the river and launched a fierce attack against the infantry positions, inflicting heavy casualties.....Sgt. Kouma discovered that his tank was the only obstacle in the path of the hostile onslaught. Holding his ground, he gave fire orders to his crew and remained in position throughout the night, fighting off repeated enemy attacks. During one fierce assault, the enemy surrounded his tank and he leaped from the armored turret, exposing himself to a hail of hostile fire, manned the .50 caliber machine gun mounted on the rear deck and delivered pointblank fire into the fanatical foe. His machine gun emptied, he fired his pistol [1911-A1] and threw grenades to keep the enemy from his tank. After more than 9 hours of constant combat and close-in fighting , he withdrew his vehicle to friendly lines. During the withdrawal through 8 miles of hostile territory, Sgt. Kouma continued to inflict casualties upon the enemy and exhausted his ammunition in destroying 3 hostile machinegun positions. During this action Sgt. Kouma killed an estimated 250 enemy soldiers. His magnificent stand allowed the infantry sufficient time to reestablish defensive positions. Rejoining his company, although suffering intensely from his wounds, he attempted to re-supply his tank and return to the battle area. While being evacuated for medical treatment, his courage was again displayed when he requested to return to the front....

From *The Congressional Medal of Honor, the Names, the Deed* published by Sharp and Dunnigan.

Gunnery Sergeant John Basilone

In 1942, on a black October night in the steaming jungles of Guadalcanal, Gunnery Sergeant John Basilone single-handedly wiped out a company of Japanese trying to overrun his position on the Tenaru River. With a Colt .45 pistol and two machine guns – one cradled in his arms after the other was knocked out – he stopped a screaming banzai attack and held out until dawn, when reinforcements came up. Nearly a hundred sprawled enemy dead were around his cut-off outpost. Basilone became the first Leatherneck to be awarded the Medal of Honor in World War II.

Marine Sergeant Al Schmid

Schmid boarded the troop transport George F. Elliot as part of the 11th Machine Gun Squad, Company H, 2nd Battalion, 1st Regiment, 1st Marine Division. On August 7, 1942, the 10,000 men of the 1st Marine Division, under Maj. Gen. Alexander Archer Vandegrift, the largest Marine force ever engaged in landing operations up to that time, assaulted Guadalcanal, beginning the first American offensive against the Japanese.

The Marines had expected a counterattack the moment they landed, but encountered no real opposition during their first two weeks. Then the Japanese sent a crack army regiment commanded by Colonel Kiyono Ichiki from Rabaul to retake Guadalcanal. Ichiki landed his elite troops on Guadalcanal on August 18, then marched west toward Marine positions along the Ilu River (mismarked on the American maps as the Tenaru). Lieutenant Colonel Edwin Pollock's 2nd Marine Battalion was waiting.

H Company's machine-gun squad was there also. Schmid and two other Marines, Corporal Leroy Diamond and Pfc John Rivers, manned a .30-caliber water-cooled machine gun inside a sandbag-and-log emplacement camouflaged with palm fronds and jungle greenery. The position was on the west bank of the Ilu, which was 50 yards wide at that point.



At 3 a.m., August 21, 1942, Ichiki, confident of victory, attacked by the sickly green light of flares. The Japanese yelled, jabbered and fired machine guns, trying to force the Marines to reveal their positions. The Marines held their fire.

Across the river from their nest, Schmid saw a dark, bobbing mass at the edge of the water. "It looked like a herd of cattle coming down to drink," he remembered. Fifty Japanese crossed the river yelling, "Marine, tonight you die," and "Banzai," firing their rifles as they came.

Johnny Rivers opened up on them, and the mass broke up. Screams of rage and pain came from the other side as the Japanese concentrated everything they had on Schmid's position and on another machine-gun position 150 yards downstream. Bullets whined past the Marines' heads, throwing mud and wood chips around them. Schmid's heart pounded rapidly.

The machine gun on their right stopped firing, put out of action. Then a dozen bullets tore into Rivers' face, killing him. His finger froze on the trigger, sending 200 rounds into the darkness. Cold rage rising in him, Schmid shoved Rivers' body out of the way and took over the gun. Corporal Diamond got in position to load it for him.

Every time Schmid raked the attacking Japanese he heard them yelling as bullets ripped into them. He heard one particular Japanese officer "screeching and barking commands at the others; he had a nasty shrill voice that stood out over the others." Schmid fired a burst at the voice, but failed to silence it. It would haunt him for years.

Diamond then was hit in the arm, the bullet knocking him partially across Schmid's feet. He could not load anymore, but while Schmid fired the gun, Diamond stood beside him, spotting targets. Schmid would fire across the river to the left, feel Diamond hitting him hard on the arm and pointing to the right, swing the gun and hear Japanese yelling as his bullets hit them.

Schmid now was both loading and firing the machine gun. When he got close to the end of a 300-round belt of ammunition, Diamond would punch his arm. Schmid would fire a burst, rip open the magazine, insert a new belt and resume firing. At one point a Japanese soldier put a string of bullets through the .30 caliber's water jacket. Water spurted over Schmid's lap and chest; the gun crackled and overheated but did not jam.

Schmid continued loading and firing the machine gun for more than four hours, with and without help. Somehow a Japanese soldier got through the body-choked stream and got close enough to throw a hand grenade into Schmid's position.

"There was a blinding flash and explosion," Schmid recalled. "My helmet was knocked off. Something struck me in the face." When he put his hand up, all he felt was blood and raw flesh. Then he felt pain in his left shoulder, arm and hand. He could see nothing. He collapsed on his back in the nest. "They got me in the eyes," he muttered to Diamond, who lay beside him.

The Japanese were still pouring bullets into the machine-gun position; Schmid reached around to his holster and took out his .45. Diamond heard him fussing with it and yelled, "Don't do it, Smitty, don't shoot yourself."

"Hell, don't worry about that," Schmid said. "I'm going to get the first Jap that tries to come in here!"

"But you can't see," Diamond reminded him.

"Just tell me which way he's coming from and I'll get him," Schmid replied.

Both men were helpless in the hole, and it was getting light. A sniper in a tree across the river was firing almost straight down at them. The only thing protecting them was the shelf where the machine gun stood, about 2 feet in diameter.



Although his sight had not come back, Schmid took his position between the spread rear tripod legs of the machine gun, squeezed the trigger and, with Diamond yelling directions in his ear, resumed firing at the Japanese across the river.

Private Whitey Jacobs, one of the squad's members, braved the continuous Japanese gunfire, jumped into the nest and staunched Schmid's and Diamond's wounds. The next thing Schmid knew, they were taking him out on a blanket. He had the .45 automatic in his hand. Hearing his lieutenant's voice, Schmid held out the gun. "I guess I won't need this anymore, sir," he said. Then Schmid passed out.

All night the Japanese continued their assaults, but the Marines' anti-tank guns, machine guns and artillery cut Ichiki's men down. At dawn, when it was clear the position would hold, Vandegrift sent a reserve battalion across the river to attack the Japanese from their flank and rear. Of the 800 Japanese who attacked across the Ilu on August 21, only 14 wounded were picked up, and one was captured unhurt. The rest were killed. Ichiki burned his regimental colors and committed suicide. The number of bodies counted within range of Al Schmid's machine gun ran into the hundreds. The other Marines who were there that night credited him with killing at least 200 Japanese.

John Dillinger

Pat Reilly tells agents in late June of 1934 that during the evening of April 20, 1934, he, together with Tommy Carroll, Baby Face Nelson, Dillinger and Emil Wanatka, played "hearts" for several hours and that the card game broke up around midnight; that he went into the bar to get a drink and the others went to their various rooms. Hamilton and Cherrington occupied the end room on the left side of the upstairs at Little Bohemia, Van Meter and Comforti occupying the room opposite, and Dillinger occupying the first bedroom on the left, upstairs, at the lodge. Two beds were in this room, and Reilly advised that he went up to this room having been told by Van Meter that he should sleep in the same room with Dillinger. As he entered the room, Dillinger was lying on the bed on the left side of the room, reading a detective magazine and with a bottle of whiskey on the stand near the bed; that as he came into the room, Dillinger laid his magazine on the table but that no conversation took place between them. He noticed when Dillinger turned over as though to go to sleep that he had a .45 automatic under his pillow. Reilly advised that he then took a drink of whiskey out of the bottle, which was 16-year-old bonded whiskey, the name of which he could not recall; that he then locked the door and turned out the light and went to bed on the right-hand side of the room; that on this same evening, Tommy Carroll and Jean Delaney, together with Baby Face Nelson and Helen Gillis, occupied the little cottage on the right of the lodge near the entrance.

The Capture of Machine Gun Kelly

At dawn, September 26, 1933, Memphis police, accompanied by a few FBI agents under Special Agent in Charge William A. Rorer, surrounded the Tichenor house. Armed with a sawed-off shotgun, Memphis police sergeant William Raney burst into the Kelly's room. Kelly, hung over and wearing his pajamas, was standing, holding the .45 automatic. Kathryn was asleep on the bed. They had consumed six quarts of gin during the night. Raney thrust his shotgun into Kelly's stomach and ordered him to drop his gun. Kelly dropped the gun on his foot and said, "I've been waiting for you all night." The Kellys were quickly taken into custody, along with John Tichenor and his brother-in-law, Seymore E. Travis.

In a masterpiece of public relations propaganda, the FBI later conjured up the myth which they still circulate, that Kelly cried, "Don't shoot, G-men!", at the time of his arrest. Supposedly, Kelly coined the term as an abbreviation for "Government Men." At any rate, "G-Men" fit much more nicely into the headlines than "Division of Investigation, U.S. Department of Justice", which was the Bureau's official title until July 1, 1935.



David and Goliath – 2d Lt. Owen J. Baggett

By John L. Frisbee

Many extraordinary encounters took place in the skies of World War II but none more bizarre than this.

The Tenth Air Force in India was, throughout most of its life, the smallest of the AAF's combat air forces but with a large geographical area of responsibility and an important mission. It was responsible for helping to defend the supply line from India to China and for interdicting the Japanese supply net running from Rangoon, Burma, to the north of that country. Its heavy bomber force – consisting of a few B-24s – was the 7th Bomb Group, based at Pandaveswar, northwest of Calcutta, whence it flew very long missions to targets mostly in Burma. On March 31, 1943, the 7th BG's 9th Bomb Squadron was dispatched to destroy a railroad bridge at Pynmana, about halfway between Rangoon and Mandalay and near two active enemy fighter bases. The formation was led by Col. Conrad F. Necrason, 7th BG commander. The B-24 on his right wing was piloted by 1st Lt. Lloyd Jensen whose copilot was 2d Lt. Owen J. Baggett. On that mission, Baggett was to earn a distinction believed to be unique in Air Force history. Before reaching the target, the B-24s were attacked by fighters. Colonel Necrason was severely wounded, and Jensen's aircraft was fatally damaged. Oxygen bottles were shattered, intensifying a fire in the rear of Jensen's bomber. Nineteen-year-old Sgt. Samuel Crostic slid out of his top turret, grabbed two fire extinguishers, and fought the fire in the rear of the aircraft while standing on a catwalk over the open bomb bay. The plane still was under attack by enemy fighters, taking many hits along its fuselage. To help defend the aircraft, copilot Baggett took over the top turret until Sergeant Crostic had emptied his fire extinguishers, giving the crew time to prepare for bailout. Smoke and fumes filled the B-24. Jensen ordered the crew to bail out.

With the intercom inoperative, Baggett hand-signaled the gunners to hit the silk and, nearly overcome by fumes, put on his own chute. He next remembers floating down with a good chute. He saw four more open canopies before the bomber exploded. The Japanese pilots immediately began strafing the surviving crewmen, apparently killing some of them and grazing Lieutenant Baggett's arm. The pilot who had hit Baggett circled to finish him off or perhaps only to get a better look at his victim. Baggett pretended to be dead, hoping the Zero pilot would not fire again. In any event, the pilot opened his canopy and approached within feet of Baggett's chute, nose up and on the verge of a stall. Baggett, enraged by the strafing of his helpless crew mates, raised the .45 automatic concealed against his leg and fired four shots at the open cockpit. The Zero stalled and spun in. After Baggett hit the ground, enemy pilots continued to strafe him, but he escaped by hiding behind a tree. Lieutenant Jensen and one of the gunners landed near him. All three were captured by the Burmese and turned over to the Japanese. Sergeant Crostic also survived the bail-out. Baggett and Jensen were flown out of Burma in an enemy bomber and imprisoned near Singapore. In the more than two years he was held prisoner, Owen Baggett's weight dropped from 180 pounds to ninety. He had ample time to think about his midair duel. He did not at first believe it possible that he could have shot down the enemy while swinging in his chute, but gradually pieces of the puzzle came together. Shortly after he was imprisoned, Baggett, Jensen, and another officer were taken before a Japanese major general who was in charge of all POWs in the area and who subsequently was executed as a war criminal. Baggett appeared to be treated like a celebrity. He was offered the opportunity of and given instructions on how to do the "honorable thing" – commit hara-kiri, a proposal he declined.

A few months later, Col. Harry Melton, commander of the 311th Fighter Group who had been shot down, passed through the POW camp and told Baggett that a Japanese colonel said the pilot Owen Baggett had fired at had been thrown clear of his plane when it crashed and burned. He was found dead of a single bullet in his head. Colonel Melton intended to make an official report of the incident but lost his life when the ship on which he was being taken to Japan was sunk. Two other pieces of evidence support Baggett's account: First, no friendly fighters were in the area that could have downed the Zero pilot. Second, the incident took place at an altitude of 4,000 to 5,000 feet. The pilot could have recovered from an unintentional stall and spin. Retired Colonel Baggett, now living in San Antonio, Tex., believes he shot

down the Japanese pilot, but because that judgment is based on largely indirect and circumstantial evidence, he remains reluctant to talk much about it. We think the jury no longer is out. There appears to be no reasonable doubt that Owen Baggett performed a unique act of valor, unlikely to be repeated in the unfolding annals of air warfare.

Thanks to Colonel Baggett and to Charles V. Duncan, Jr., author of *B-24 Over Burma*.

AIR FORCE Magazine / July 1996

Texas Ranger Joaquin Jackson

Texas Ranger Joaquin Jackson who spent the later part of his illustrious career looking after the harsh, massive Texas Big Bend Country, packed a Colt .45 auto throughout his distinguished career. When asked why he carried Colt's .45 Government Model, he replied in typical Ranger fashion... 'Because they don't make a Colt .46!'



The Death of Bonnie and Clyde

Whatever the exact scenario was, Bonnie and Clyde became rudely aware of the officers' presence and purpose. At that point, Clyde gunned the motor as he and Bonnie both went for the weapons they carried in their laps. Clyde had a sawed-off shotgun between his knees, while Bonnie had a .45 automatic in her lap. Their response here was the same as it had been at Joplin, Platte City, Dexter and every other place where they had been confronted by "the laws" -- to shoot and run.

This time, however, they did not have time to fire a single shot, and for one brief instant they fully appreciated that same bitter surprise, that same searing pain and that same shocking realization of the grip of death that their victims had each been forced to experience before them. The officers opened up with a deadly barrage of gunfire from their automatic weapons. Clyde's foot came off of the clutch, and the car started forward, but lacking impetus, rolled ahead slowly until it stopped a few feet later. Taking no chances, the officers maintained their unrelenting stream of fire on the vehicle and its occupants.

When the gunfire stopped, an awesome quiet descended over the scene. All eyes were fixed on the bullet-riddled sedan in anticipation of a counterattack. Although it would have been impossible for anyone in the car to have survived, there was an aura of immortality that had attached itself to Bonnie Parker and Clyde Barrow by means of their reputation. Bonnie and Clyde always had greater firepower, Bonnie and Clyde always fought back, and Bonnie and Clyde always managed to escape. Slowly the officers straightened their cramped legs, and with guns still at the ready, approached the car.

Bonnie Parker and Clyde Barrow were dead; their bodies were slumped over inside the car -- each had approximately 50 bullet wounds. Bonnie was wearing a red dress, red shoes, and a red and white checkered hat. Her .45 Pistol was still on her lap. Clyde wore a suit, and his pearl-handled sawed-off Winchester Model 1901 ten-gauge shotgun leaned on his leg with its muzzle on the driver's floorboard. One of the lenses of his sunglasses had been shot out. The ticking of his Elgin pocket watch was the only sound coming from the car. Bullets fired into the car's engine had even killed the V8. One of the officers turned from the car and breathed a sigh of relief, a personal spontaneous expression that symbolized the feelings of law-abiding citizens throughout the Midwest.

-- from Captain Ernest M. Raub, Missouri State Highway Patrol



First Lieutenant Robert M. McGovern, United States Army

On January 30, 1951, IX Corps Division, 1st United States Cavalry, encountered stubborn resistance near Kamyangjan-ni, a small hamlet east of Suwon, Korea. Company A of the 5th Cavalry Regiment had to take yet one more hill on its advance north.

The calvarymen had seen relatively little action since the beginning of Operation Thunderbolt. It was an exhausting climb up a hill that day, and the strain of physical exertion was beginning to show on the 23-year-old McGovern. Combat was far more physically challenging than his training had prepared him for.

The hill before them looked no different than any of the others they'd attacked in recent days. He deployed his thin platoon in a skirmish line and, at his signal, they started up. Without warning, the Chinese opened fire. From more than a dozen foxholes rifle fire tore into the ranks of the U.S. soldiers.

A machine gun raked the advancing cavalrymen before they could seek cover. One round slammed into McGovern's side, tearing a gaping hole. He crawled behind a boulder, where he applied a field dressing to the wound. His platoon sergeant crawled up and suggested that McGovern retreat back down the hill. He refused, assuring the NCO that he would be all-right.

He told the sergeant, "Get the men ready, in the next break of fire we're going up." He soon stood and began climbing the hill and dodged from boulder to boulder until he closed within a few yards of the machine gun. Behind him, the surviving members of the platoon took cover and laid down a covering base of fire. Before the young officer could launch his final attack, the Chinese threw and rolled a vicious barrage of hand grenades at the group, again halting the advance. Men cried in pain as the hot metal found flesh. One of the men broke cover and ran down the hill, only to be shot dead by the Chinese. Others appeared to be in a state of panic, too. Something had to be done. Without warning, he burst from cover and, alone, he ran toward the Chinese machine gun.

Triggering his carbine, he ran across the rocky ground toward the enemy automatic weapons. Enemy rounds tracked him and tore the carbine from his hands. Undaunted, he pulled his .45 automatic pistol from its holster. Firing his pistol and throwing grenades, he closed on the nest. He killed seven protecting Chinese riflemen before one got him. Just as his last grenade exploded in the machine gun nest, killing its three gunners, enemy fire caught him full in the chest. He died there on the lip of the enemy position.

The recommendation for the Medal of Honor, prepared for him at his men's insistence, slowly wound its way through the bureaucratic channels. In the meantime, public support for the conflict in Korea waned. President Truman became the target for ever-increasing criticism over the conduct of the war. The once well-liked Chief Executive saw his popularity drop drastically. When his Medal of Honor was announced in January 1952, Robert's father, J. Halsey McGovern of Washington, created a stir when he refused to accept the award. He also refused to accept the Silver Star posthumously awarded his second son, a member of the 187th Airborne Regiment who was killed-in-action on February 10, 1951. The senior McGovern's refusal was based on his belief that medals were superfluous. He felt that they did not do justice to all of the heroes of the war in Korea. And, as he told reporters, he did not feel that Truman "was fit to confer medals on anyone's sons."

Several Members of Congress offered to make the presentations to the hero's father, but still be refused. He stated that he did not want to turn refusal into a "political thing." There the matter ended. No presentation ceremony was ever held. Nonetheless, the name of Robert M. McGovern was entered onto the rolls of America's greatest heroes.

-Arlington National Cemetery Web Site



My Favorite 1911 Web Sites

Note: Log onto the Web and Click on these links. They will point your browser to the page.

Beast Enterprises - Geoff Beneze's Custom Gunsmithing Page
<http://www.beast-enterprises.com/>

Colt Automatic Pistols - A very neat page with info and pictures on all the rare old Colt autoloaders.
<http://www.coltautos.com/cahome.htm>

Chuck Taylor's "Is There A Best Pistol?"
http://www.chucktaylorasaa.com/best_pistol.html

How to Build a 1911-style Pistol
<http://www.larue-targets.com/Extreme1911.html>

Kimber - The Factory "Custom" Pistol
<http://www.kimberamerica.com/>

The Colt 1911 Home Page
http://www.netaphore.com/guns/1911_home_us.html

The Government Model 1911 .45 ACP Pistol Page
<http://www.k4cybertech.net/rayvigator/Govt.M1911/index.htm>

The M-1911 Home Page - John Caradimas' excellent 1911 resource
<http://www.m1911.org/>

Firearms Tactical's .45 ACP Ammunition Performance Data
http://www.firearmstactical.com/ammo_data/45acp.htm

Operation of the 1911 .45 ACP - Michael Kay's explanation of how the 1911 actually functions
<http://www.ozemail.com.au/~mickay/colt1911.htm>

Shuemann's Barrels - High quality custom pistol barrels plus some excellent information on pistol timing and other technical issues
<http://www.schuemann.com/>

Springfield Armory - In my opinion, the best 1911 bang for the buck
<http://www.springfield-armory.com/>

MODEL1911A1.COM - Oliver de Gravelle's site on WWII production 1911A1's. This site is a must see for collectors of the 1911A1. It features an extensive collection of pictures and production history of the guns built during WWII by Colt, Remington, Ithaca, and Union Switch.
<http://www.model1911a1.com/>

Wilson Combat - Custom pistols, parts and gunsmithing
<http://www.wilsoncombat.com/>

The Sight's 1911 Page - The source of this document, the Sight's 1911 page is devoted to the lore, history, and use of the 1911 pistol.
<http://www.win.net/~sydwdn/1911/1911.htm>



Recoil Spring Selection Tips from Wilson Combat catalog By Bill Wilson

As a rule of thumb, you should use the heaviest recoil spring possible, which does not interfere with the pistol functioning.

The spring tension requirement is affected by many factors, including the ammunition used, grip pressure, compensators, slide to frame friction, pistol type etc. The following procedure will help you determine what is the proper recoil spring for your gun.

First, try the recommended standard spring for your load/pistol combination.

Watch for extraction related jams and failure of the slide to lock back. This is an indication of a very heavy spring. Use a lighter one.

Use SHOK-BUFF and watch them closely. If they do not last 700-1000 rounds, you have a weak spring. Your recoil spring should be replaced every 2000 rounds.

RECOMMENDED RECOIL SPRING

| | Light Target Load | Full Charge Load |
|---------------------------------|-------------------------|------------------------|
| Govt/Gold Cup (stock) | #10 | #18.5 |
| Govt/Gold Cup (compens.) | #9 | #15 |
| Govt/Gold Cup (.38SP/9mm stock) | #10 | #15 |
| Govt/Gold Cup (.38SP/9mm comp.) | #9 | #13 |
| Delta Elite (10mm stock) | #18.5 | #24 |
| Govt/Gold Cup (.40S&W stock) | #13 | #22 |
| Commander (.45 stock) | #12 | #20 |
| Officers (.45 stock guide) | #18.5 | #24 |
| Springfield Compact (.45 stock) | #20 | #24 |

Full charge load refers to IPSC major or factory hardball. Light target load refers to a download of about 20%.





U.S. Army Marksmanship Training Unit Standards & Procedures Rebuild the .45 M1911A1 Pistol to USAMTU Specifications

1. The pistol will be set up and held in a recoiling type test cradle or machine rest such as the Heg Rest, Ransom Rest or equivalent.
2. Test ammunition shall be caliber .45 Match hardball (full metal jacket) or wadcutter as appropriate. Average extreme spread for three consecutive groups of ten rounds each are not to exceed 2.5 inches with no group larger than 3 inches for wadcutter pistols and 3 inches average for hard ball. No hardball group may exceed 3.5 inches.
3. Fitting the slide to the receiver
 - a. Select a slide which fits as closely as possible on the receiver, having a minimum of horizontal or vertical movement on the receiver.
 - b. Relieve the outer edges of the rails on the receiver to remove all phosphate finish from the bearing surfaces.
 - c. The slide is now ready for initial fitting to the receiver.
 - d. Place the slide (with the muzzle end upright) into a smooth jawed vise approximately 3 inches from the muzzle end (meaning the three inches of the slide aft of the muzzle are above the vise jaws). The top of the slide should be extended out from the left side of the vise so that the vise is gripping near the slide's rails.
 - e. Gently squeeze in steps of 1 inch at a time, for the complete length of the slide. Take extreme care not to squeeze excessively. The desired fit is a snug fit and yet the slide should be capable of being moved on the receiver by hand. Note that the slide may be squeezed much harder at the rear of the slide without crushing (because this area is the beefed up section of the slide!).
 - f. After the squeezing is completed, apply lapping compound (GK-7A or any 300-400 grit compound) to the slide. Slip the slide onto the receiver while the receiver is correctly held and supported in the vise. Work the slide back and forth until the slide moves freely without binding on the receiver's rails. Wash out the compound with solvent (or Gun Scrubber, etc.), replace the slide on the receiver and check for movement by placing the slide into the firing position. The movement check is made by grasping the muzzle end of the slide in one hand and the receiver in the other hand. Then move each part in opposite directions and check for any HORIZONTAL movement.
 - g. If any horizontal movement is detected, repeat steps 3a through 3f as many times as necessary until there is no perceptible horizontal movement.
 - h. After all horizontal movement is eliminated, the slide is then ready for vertical fitting. With the slide in the firing position (also called the "battery" position), grasp the muzzle end of the slide and determine the amount of vertical movement.
 - i. Remove the slide and insert a parallel bar for swaging the receiver rails. Normally a bar 0.1170 inches thick is a good one to start with. A set of ten bars is needed, graduating from



- 0.1100 inches thick to 0.1200 inches, 5 inches long and 3/4 inches wide.
- j. Using a 4 ounce ball peen hammer, swage the receiver's rails. The recommended technique for swaging is to hold the bar snugly and straight against the channel surface of the receiver and then use a highly polished hammer which has had the edges of the head broken lightly. Use an overlapping stroke with the hammer face being held as nearly parallel to the rail's surface as possible. The rails must be swaged as smoothly and as evenly as possible.
 - k. When both rails are indicating an even fit on the parallel bar, again relieve the edges of the rails to remove any high spots. Use GK-7A for lapping the slide to the receiver.
 - l. After lapping, recheck for VERTICAL movement. If any vertical movement still exists, repeat the swaging with the next smaller (thinner) parallel bar. Continue the swaging process until no perceptible vertical movement is noted.
 - m. Lap the slide and receiver until the slide will move under its own weight when the receiver is tilted and also no loose play (either horizontal or vertical) is noted.
 - n. Polish all work surfaces to remove all hammer strike marks or file marks or other blemishes.
 - o. Check the fit most carefully as this fit is the foundation of the entire operation. Repeat any of the earlier steps if a perfect fit is not achieved.
4. Fitting the barrel to the barrel bushing
 - a. Get an arbor that will hold an oversized bushing and set up the arbor between centers on a lathe. Turn to achieve a good fit. The nominal outside diameter is 0.7020 inches. While turning the bushing, be careful not to deform the retaining lug.
 - b. Measure the barrel diameter at the muzzle end. Install a precision reamer in the lathe and ream the inside of the bushing to the exact size of the muzzle end of the barrel. This should be 0.5790 inches.
 - c. With a high speed hand grinder, grind a slight radius in the bushing to allow the barrel to swivel slightly. This permits the barrel to enter the locking lugs of the slide without any binding. Take extreme care when grinding the inside radius so you do not remove any metal from the center of the bushing as this is an important fit (actually, it is the most important fit!) and must be precision ground. The barrel must slide back and forth in the bushing without any horizontal or vertical play.
 - d. The bushing should be a press fit and should require the use of a barrel bushing wrench to install or remove it from the slide.
 5. Fitting an oversized barrel to the slide.
 - a. Insert a new oversized barrel into the slide and move it as far to the rear of the slide as possible. Observe the amount of steel to be removed from the barrel's tang in order to achieve the desired fit of the barrel hood and lugs into the battery position (firing position) of the slide. A layout die is recommended to fit the tang squarely to the slide.
 - b. The tang must be cut in a manner to maintain the original 90° angles in order to match the slide locking recess. This is to



PFC. Arthur Kranz, Korea 1952

insure that the barrel tang will enter the locking recess of the slide without binding the tang or locking lugs as the barrel locks up into the firing position.

- c. When the tang is fitted to the recess in the slide, start to remove metal from the flat surface of the tang in order to fit the hood and lugs into the slide. Care must be taken not to remove too much metal. This fit should be as tight as possible in order to assure that a good fit will occur when the slide and barrel are in the firing position. A layout die is recommended to fit the tang squarely to the slide.
- d. After the fitting has been made, use an alignment gauge 8 inches x 0.4375 inches with a 3/32 inches x « inches tip inserted with the small tip to the rear of the slide in order to check alignment of the barrel with the firing pin. If the barrel is perfectly aligned, the small end of the tip will enter the firing pin aperture center and assure a center strike of the firing pin on the cartridge primer. If the barrel locks in the slide too high for the gauge tip to enter the firing pin aperture, it will be necessary to weld an appropriate thickness of metal into the slide above the barrel in order to get the proper alignment of the firing pin and barrel.
- e. With a new barrel and bushing fit into the slide, place the slide with the barrel installed onto the receiver, making certain that the locking lugs on the bottom of the barrel fit into the recesses of the receiver without binding on any side. If there is rubbing on either side, make the necessary adjustments to assure a loose fit in the locking log recesses. At this point there must be a snug fit in the barrel tang and hood. A snug fit should also exist between the barrel bushing and slide as well as the barrel bushing and barrel.
- f. Use a lug cutter, such as is available from Brownell's, to cut the locking lugs. The lugs must ride smoothly onto the slide stop pin, with the slide stop pin holding the barrel snugly against the top of the slide when the barrel and slide are in the firing position. After a tight fit has been achieved, polish the locking lugs with a high speed grinder and suitable rubberized abrasive tips. A Dremel tool works adequately. Take extreme care during the polishing to not polish on one side more than on the other. The lugs must be kept perfectly level. Frequent checks should be made using Dykem Blue on the lugs to assure perfect fit on the slide stop pin. Continue polishing until lockup is smooth but snug and resting equally on both sides of the lugs. At this point if the barrel hood and tang are too tight, remove a small amount of metal from the tang with a very light cut in order to permit a smooth lockup. It is good practice to use lapping compound to get a perfect fit.
- g. After this fit is obtained, check the feed ramp on the barrel to be certain that the feed ramp on the barrel is forward of the feed ramp on the frame by approximately 1/32 inches. This will insure that the nose of the cartridge will not hang up as the cartridge is loaded into the chamber from the magazine. Keep the angle on the barrel feed ramp the same as the ramp on the receiver (approximately 33°). The barrel feed ramp includes approximately « the lower diameter of barrel ground on the lower

half of chamber end. The feed ramp on the barrel must not overhang the ramp on the receiver. However, the feed ramp on the barrel may be set forward of the feed ramp on the receiver as much as 3/32 inches. The two feed ramps may be checked by locking the slide to the rear and looking through the ejection port.

6. Fitting the trigger

- a. There are two types of triggers used on the U.S. Army's National Match .45 pistols: the standard Colt steel trigger and the aluminum National Match trigger found on the Gold Cup. Each trigger comes in two different length (long and short). The aluminum long trigger is slightly shorter than the long Colt trigger.
- b. Using a number 36 drill, drill a hole in the trigger for the set screw. This hole will be tapped with a 6-32 tap. After tapping the hole, install a 6-32 x « inches Allen head set screw for the trigger stop screw. After completing this operation, check the trigger in the trigger opening of the receiver. Since most triggers are oversized in their width dimension, it is necessary to remove metal from each side of the trigger until the trigger will fit into the receiver without horizontal or vertical movement. When this fit is achieved, the next step is the trigger job, which includes fitting the sear and hammer.



7. Sear and hammer fitting

- a. It is critically important that all original angles be maintained on the hammer and sear. The hammer hooks are then cut down to 0.0200 inches by using a thickness gauge. Placing the thickness gauge squarely on the hammer, file the hammer hooks down to 0.0200 inches using a smooth mill file.
- b. Check the sear and hammer for proper engagement and proper angles using a hammer and sear mating fixture.
- c. Polish the sides of the new National Match sear so they are smooth. Be sure the sear's sides are free of burrs or rough tool marks. Also polish the disconnecter and trigger yoke (bow) to assure smooth operation when the pistol is reassembled and the moving parts are under normal working pressure.
- d. The half cock notch is cut on each side of the hammer an even amount, so as to leave the hammer notch 0.1250 inches wide and then the depth of the sides of the half cock notch are cut down to the base of the hammer using a smooth mill file. This leaves the full half cock notch to catch the sear in the event the hammer falls. This provides complete safety on the same principle as is produced in the Colt factory for the .45 Gold Cup.

8. Trigger pull

- a. Assemble the hammer, sear, disconnecter and sear spring. Check for the desired break and weight of trigger pull. The trigger pull may be lightened by honing a slight radius on the point of the sear. To make a heavier pull, increase the engagement of the sear by increasing the angle on the point of the sear.
- b. After proper operation and trigger pull have been obtained, adjust the trigger stop to have approximately 1/8 inches travel after the break. This is necessary to obtain the tolerances

needed for the disconnecter to work after each shot is fired.

- c. Insure that the weight of the trigger pull is within the limits prescribed by N.R.A. rules and regulations and still maintain the required safety factors. The weight of trigger pull varies with each type of pistol used. Minimum recommended weights are as follows:
 - i. .45 ACP 230 FMJ (ball) 4 lbs. minimum
 - ii. .45 ACP wadcutter 3« lbs. minimum
 - iii. .38 Super 2« lbs. minimum

9. Sights

- a. Sights used on .45 and .38 Super target pistols are the micrometer adjustable style. The Bo-Mar sight system is recommended due to its durability and precise movement. The point of impact may be moved as little as ¼ inches on the target. Install the sights according to the manufacturer's instructions and make certain the N.R.A. specifications are met for competition pistols. Rules vary from time to time and the latest copy of the N.R.A. rules should be consulted.

10. Common malfunctions

- a. Failure to feed properly
 - i. In most cases the cartridge will nose upward against the top of the barrel hood and chamber. This can be caused by the feed ramp on the barrel having less than the necessary angle or the feed ramp on the barrel overhanging the feed ramp on the receiver. To correct this problem, grind the feed ramp on the barrel to a more forward angle and make sure the barrel does not overhang the feed ramp on the receiver. Polish all surfaces in order to remove all tool marks.
 - ii. Very frequently the magazine follower is bent to an improper angle or else the lips of the magazine may be too tight. This prevents the magazine from releasing the cartridge in time to allow the round to enter the chamber. If the cartridge noses UP, bend the follower DOWN. The correct angle should be 70° to 75°.
- b. Failure to chamber the round
 - i. This is characterized by the slide stopping 1/8 inches to 1/4 inches out of the full closed, battery position. Correct this problem by relieving the tension on the extractor and/or rounding off the bottom of the extractor to permit the extractor to cam itself onto the base of the cartridge with greater ease.
- c. Cartridge "stove pipes" during ejection
 - i. This malfunction is usually caused by the recoil spring being too strong (stiff) and not permitting the slide to go fully rearward, having the slide go fully rearward but coming forward too fast or because the ejector does not have a good square face. The recoil spring used for firing 230 grain hardball (full metal jacket; FMJ) rounds normally has 29 to 33 coils. If you find it necessary to cut down the recoil spring, cut off only one coil (some prefer « coil) at a time until the problem is corrected.
 - ii. If the ejector is found to be round or worn, file the

ejector's face square and maintain the original angles. Sometimes it is necessary to install a new ejector when the pistol is firing .45 wadcutters or .38 Super. This is because there are inadequate recoil forces to move the slide completely to the rear, permitting the cartridge case to exit the pistol in time.

- d. Misfires
 - i. First examine the detent made by the firing pin on the primer of the misfired cartridge. If the primer is not dented enough there could be a broken firing pin, burred firing pin or the firing pin could be binding in the firing pin retainer plate. Carefully check all of these points.
 - ii. It is possible to have a weak mainspring or the mainspring could be hanging up in the mainspring housing (due to a burr on the spring or in the housing itself).
 - iii. Excessive headspace can cause misfires. Normal headspace is 0.0080 inches to 0.0120 inches and should NEVER exceed 0.0120 inches. If the shooter is using his own reloads, examine his cases for proper length.
 - e. Pistol fires full automatic
 - i. This can be caused by several things: improperly adjusted trigger stop (too close), too light a trigger pull, disconnecter too short due to excessive wear or polishing or the center leaf of the sear spring is simply too weak.
 - ii. If the problem is traced to an improperly positioned trigger stop, readjust the trigger stop to permit not less than 1/8 inches travel after the break.
 - iii. Make sure the trigger pull is not less than the appropriate value specified in item 8c. Increase the trigger pull weight by increasing the engagement of the sear and hammer.
 - iv. If the problem is traced to the disconnecter, simply replace it. Polish it before installation to remove and burrs.
 - v. If the center leaf of the sear spring has lost its temper and will not longer hold its set, replace the sear spring with a new one.
11. Differences between .45 ACP and .38 Super pistols
- a. While the pistols are generally built in the same manner, some differences do exist. The .38 Super has a recoil spring composed of softer 0.0330 spring wire.
 - b. The .38 Super extractor is specially designed and fitted to have less tension gripping the cartridge case.
 - c. The .38 Super extractor claw is deepened and shaped differently in order to cam onto the cartridge case.
 - d. The trigger pull on the .38 Super is set to 2« pounds.
 - e. Gold Cup type magazines are used in the .38 Super.



WHY YOUR 1911 AUTO PISTOL WON'T WORK!! **by Duane Thomas**

Handguns Magazine, November 1994

Probably the most commonly heard complaints about the 1911 .45 auto are, "It doesn't work out of the box." "It jams all the time." "You've got to put hundreds of dollars into customizing it.....and it still doesn't work!" There's a certain amount of truth to these criticisms. Every time I go to a high-level handgun training class, there's at least one other class attendee shooting a customized 1911. I have yet to see such a shooter complete a full day's training without his or her gun choking numerous times. As a matter of fact, I've seen more jams — and experienced them myself — with the 1911 than with all other types of handguns combined. Why is that? In this article, I'll try to address what I consider the half dozen or so most common reasons why your 1911 auto won't work. Before we start, let me make one thing very clear: I love the 1911. I've carried Colt Government Models and Combat Commanders for years, and I'm morally certain I'll carry them again. Some folks have the attitude that the 1911 is perfect — no weak points, no improvements possible. What a nonsensical attitude! Only with a mature appreciation of the design's strong and weak points and a knowledge of the most common mistakes and pitfalls waiting to trap a 1911 user will you be able to get the most from these guns. Now, why might your 1911 auto not work? I can think of six reasons. These are, in no particular order: (1) incompetent customization, (2) inappropriate ammunition, (3) lack of lubrication, (4) cheap magazines, (5) flaws in the basic design and (6) a propensity toward small-parts breakage.

INCOMPETENT CUSTOMIZATION

Gunwriters love penning articles about their heavily customized .45 autos (and God knows I've written my fair share of them over the years). This seems to have imbued the gunbuying public with the belief that a certain amount of customization is absolutely mandatory on a 1911. Well, that isn't necessarily so. I've spent thousands of dollars on customizing 1911s. In the process of doing so, I've discovered that most of the things you can have done to the gun are simply a waste of money. The more I've learned about the 1911, the less I like to tinker with it. I do feel there are a few things (none of which is extremely complicated or expensive) that can be done to make the 1911 a better gun, but in general I think you're better off leaving the piece alone.

Let's assume you've just gotta have your 1911 customized. How do you choose a pistolsmith? Here's how I look at it: Let only the very best people touch your gun. Conventional wisdom has it you should choose a pistolsmith close to you geographically, so if anything goes wrong with his work, you can take the gun back for correction without having to send it out of state, wait weeks or months for its return and go through the hassle of shipping the gun through an FFL dealer coming and going. I profoundly disagree with this. There simply aren't that many good pistolsmiths out there (although there are a lot of people who think they're good pistolsmiths), and the chances of finding someone truly excellent close to you are very slim. Yeah, it's more hassle to send your gun away to one of the top .45 shops and you'll have to wait longer to get it back, but when you do get it back, it'll probably work, which is not something you can say when you hand it over to the local hack-'n'-slash artist.

At one time, customizing a 1911 made a lot more sense than it does today. Until about a decade ago, the guns available from the factories were set up to feed hardball only. Sights were horribly tiny. Trigger pulls might or might not be extremely stiff and heavy. If you're buying a straight GI gun today, perhaps that might still be the case. If you go for a top-of-the-line gun like an Enhanced Model Colt, however, today's 1911 will come out of the box with a hollow point-compatible ramp and throat job; decent, high visibility sights; a beavertail grip safety; a beveled mag well; and a lowered and faired ejection port. The trigger pulls on recent-production Colts I've tried have been in the acceptable to excellent class. What more do you want?

One of the areas where you want to be especially careful about modifying your 1911 is in the area of trigger pull. Ever seen the hammer follow on a 1911? You're firing the gun, the slide cycles and recocks the hammer, but instead of staying cocked so you can fire the next shot, the hammer follows the slide down and falls to half cock. The same thing can happen when dropping the slide while loading the gun. I've seen both these things happen and have had them happen to me.

You almost never see this happen on a stock gun. You'll see it most commonly with guns on which some enterprising pistolsmith has lessened the hammer/sear engagement and fitted a heavy steel trigger and added a heavy recoil spring. When the slide slams forward on the gun, the gun moves forward, but the heavy steel trigger wants to stay in one place (it's called inertia, folks), so it actually moves back slightly in its track. If the hammer/sear engagement has been compromised, either through taking off too much metal or changing the angle of the hammer hooks, the trigger can actually bounce far enough back to jostle the hammer hooks and sear out of engagement, causing the hammer to fall to half cock.

You also see this happen with guns on which old mil-spec parts have been substituted for the stock Colt parts. Stock Colt parts and most of the quality aftermarket hammers and sears (like Brown, Wilson, Cylinder & Slide, etc.) are heat-treated and hardened all the way through. The old mil-spec parts, on the other hand, are only surface-hardened, and when a smith takes metal off these parts to do a trigger job, he exposes the soft steel beneath the hard "skin." Under use, these soft surfaces begin topeen each other. Typically, with this problem you start out with a decent trigger pull weight: say 4 1/2 pounds. As you use the gun, however, the trigger pull starts dropping in weight - four pounds, 3 1/2 pounds, three pounds - as the hammer hooks and sear round off, and suddenly your hammer starts following. Can you get around this problem simply by lowering the slide gently to chamber a round? Well, no. The 1911 was designed to chamber a round with the slide moving at full speed. Easing the slide forward will quite often result in a failure to feed. Also, never loading the gun except by easing forward the slide kind of rules out ever doing (or practicing) a speed reload from slidelock, doesn't it? And if you keep the gun for home defense in Condition Three (hammer down on an empty chamber, full magazine in place), I suggest a lot of practice swiftly racking the slide to chamber a round.

Some shooters (and many pistolsmiths) recommend squeezing the 1911's trigger and holding it to the rear while dropping the slide during loading, as well as when doing a speed reload from slidelock. This prevents trigger bounce and also activates the weapon's disconnect, preventing the hammer hooks and sear from pounding each other. I consider this a very dangerous practice.

For one thing, under the stress of a violent encounter (or even while shooting on the range, with or without match pressure) many shooters experience a phenomenon called "cognitive dissonance," which basically means that stress negatively affects the mind's perceptions and clearness of thought. One of the most common results of cognitive dissonance is that you lose your short-term memory. (This is why it's almost impossible for shooters to count their rounds during a gunfight.) If you're doing something that requires you to perform actions in a certain sequence, there's a very real tendency to screw up the order in which you do them. Thus, under stress, "squeeze the trigger, hit the slide stop" becomes "hit the slide stop, squeeze the trigger," and you've just accidentally fired your gun, probably hitting something you weren't supposed to, possibly even killing an innocent person.

Besides, holding the trigger to the rear while loading the gun is a crutch for an incompetent trigger job. You have two ways around this problem: (1) Leave the gun stock or (2) let only the best people work on your gun. (Where have I heard that before?) Some pistolsmiths will tell you that even a good trigger job will allow the hammer to follow occasionally unless you press the trigger before dropping the slide. When I was discussing this matter with nationally famous pistolsmith Bill Laughridge of the Cylinder & Slide Shop (Dept. GAH, 245 E. 4th Street, P.O.Box 937, Fremont, NE 68025, phone: 402/721-4277), he told me that, in his opinion, a pistolsmith who gave a shooter a trigger job that allowed the hammer to follow for any reason hadn't done his job very well. The Cylinder & Slide Shop is one of the few places of which I'm aware that can give you a trigger job resulting in an excellent trigger pull while leaving the gun as durable as an unmodified version.

I hope it goes without saying that modifications that predictably adversely affect reliability-like tightening the slide to frame fit-are a bad idea. The bottom line on customization, as far as I'm concerned, is this: Leave the gun alone. If you must customize, do so with extreme moderation and let only the best people touch your gun. You'll be amazed at how much better the piece works when you haven't paid some incompetent person to ruin it.

INAPPROPRIATE AMMUNITION

Shooters want to stuff everything imaginable into their 1911s, and then they seem amazed when much of it doesn't feed reliably. Let's try to avoid as much of the wishful thinking here as possible, shall we? The 1911 is not as tolerant as some of the more modern designs in terms of the range of different bullet profiles it will reliably feed. The fact is that the 1911 was designed to feed hardball, and no matter what you do to it there's really no way around that. Now, I'm not one of those people who says you should only carry hardball in your 1911, but I will say that the farther your .45 load departs from a hardball profile, the more you're asking for trouble.

At one time Colt, Springfield, etc., produced all their .45 autos with feed ramps and barrel throats set up exclusively for hardball; hollow points need not apply. In the past decade or so this has changed. Now you can have a 1911 .45 straight from the factory with a decent ramp and throat job, and the guns will reliably feed hollow points. However, I still believe you're better off if you make feed reliability a main priority when choosing your .45 ammo.

Hollow points that feature a rounded, hardball-type ogive are far more feed-reliable than bullets that have flat-nose, truncated-cone or semi-wadcutter shapes. The .45 ACP is a short, fat, wide cartridge, which is not the most feed-reliable cartridge profile in the world to start with. Aggravate that problem by getting too far from the reliable hardball shape in a gun that was designed from the ground up to feed hardball, and you're just begging for jams.

Some folks argue that your primary consideration in load selection should be stopping power. I disagree: The primary consideration should be feed reliability. Even if a particular .45 load does have deeper penetration (or lack thereof), more expansion (or lack thereof), a "one-shot stop" rating a few percentage points higher than other loads or any other traits you deem desirable, all that does you no good if you can't fire the gun because your "wonder bullet" is hung up on the feed ramp.

If stopping power is the name of the game, the good news for .45 lovers is that the .45 seems to be very forgiving in terms of load selection. If it's a good hollow-point load that'll fit into the chamber of a .45, it should give you a usable amount of stopping power. That being the case, you're free to place the emphasis back where it belongs on feed reliability.

There are a number of effective hollow-point loads out there that feed extremely well in modern 1911s. Hollow-points that exhibit excellent feed reliability are Winchester 185-grain Silvertip JHPs, Remington 185-grain JHPs and 230-grain Golden Saber JHPs, Federal's 230-grain JHP load and Black Hills' 185-grain and 230-grain JHPs. Winchester's 230-grain Black Talon JHP load (now sadly unavailable to civilians) was also a very feed-reliable load.

Hollow-point loads for the .45 ACP that, in my experience are testy feeders include the Federal 185-grain JHPs and 230-grain Hydra-Shoks, the Hornady 230-grain JFPs and the CCI-Speer 200-grain JHP "flying ashtrays."

LACK OF LUBRICATION

All handguns require lubrication to work their best. My experience and the experiences of the top-flight pistolsmiths whose brains I've picked on this subject lead me to conclude that this is even more true for the 1911 than with most other firearms. Whenever you start feeling smug about mankind's technological progress, remind yourself of this: We have not yet progressed to the point where our handguns will function unless we smear them with dinosaur grease.

How long has it been since you last lubricated your 1911? If it has been more than about three days, the piece is probably bone-dry. Oil evaporates; if you carry the gun muzzle down in a holster, gravity pulls the oil down the slide rails, around the bushing and out of the gun. Some folks tout the various teflon-based lubricants as the cure for this. In my experience, they don't last one bit longer than the natural products.

Every few days, take a minute or so to lube your 1911. Unload the gun; lock the slide to rear. Put a small drop of oil on each slide rail and let it run into the gun. If you have a Colt with the firing pin lock, you might want to take this opportunity to put a small drop of oil on the firing pin lock plunger in the slide. Lightly rub a thin coat of oil on the exposed barrel where it rides the bushing when the gun is cycling. Let the slide go forward and put one small drop of oil on the front of the barrel hood where it meets the front of the ejection port. Cycle the gun's action a few times, and you're in business. Frankly, I like to do a more leisurely job of lubing my 1911s in which I actually field strip the piece, but the quick-'n'-easy method I've just described will be sufficient.

Also, while you're lubricating your 1911, don't overdo it. You don't want to oil your gun like you would oil your salad. Excess lube, especially on the breechface, can attack primers and turn your chambered round into a dud.

CHEAP MAGAZINES

I haven't quite figured this out yet, but it seems there are a lot of folks quite willing to pay five or six hundred dollars for a quality 1911 and invest a small fortune in customizing it, but when it comes time to buy magazines to feed the beast, they suddenly try to save a few bucks by buying EL Cheapo-brand mags. Suffice it to say, the magazine is one of the most important parts of the firearm, and buying trash instead of top-quality mags is kind of like wimping out and putting Brand-X retreads on a Porsche. I don't much care for the eight-round mags with their folded metal followers that Colt provides with their guns (except the 1991A1s, which come with a seven-rounder featuring the traditional split metal follower). If you shoot a lot, sooner or later the folded metal follower in the eight-rounder is going to pop over the slide stop inside the gun, failing to lock the action open when the gun is empty and necessitating manually ripping the magazine out of the gun. The split metal follower in the seven-rounder will do the same thing. This is the sort of thing that can get you killed.

I don't like any eight-round .45 mags. In general, they cause more problems than they're worth, such as difficulty to loading to full capacity, failure to feed the top round off the magazine, extreme difficulty snapping the mag into the gun and failure to lock the slide open on an empty magazine. Eight-round magazines were designed for competition use to feed extremely long bullets like the H&G #68 semi-wadcutters. Shorter rounds, like most hollow points, won't feed reliably out of these magazines.

There is a bewildering array of aftermarket 1911 magazines out there. I've tried most of them, so let me make this easy for you. If you want good mags that will work, I suggest the stainless steel Wilson-Rogers seven-rounders. These are available from Wilson Combat (Dept. GAH, Route 3, POBox 578, Berryville, AR 72616; phone 501/545-3618). The Wilson-Rogers follower design is excellent, and you won't have to worry about it popping over the slide stop inside the gun. There are other decent seven-rounders out there, but remember, I'm making things simple for you, and when you buy the Wilson mags, you can pretty much bet the farm they'll work.

The Wilson-Rogers design comes standard with a thick-plastic slam pad. If that bulky floorplate protruding from the butt of your gun adds too much length to the grip for your taste (vis-a-vis, concealment), Wilson's also sells thin, concealment-oriented replacement floorplates for their mags that are more subtle. An even more low-key approach is to pull the spring and follower out of a Wilson-Rogers and stick it in a stock Colt magazine. This gives you a magazine that doesn't protrude from the gun at all, but still has the great Wilson-Rogers follower design. When I carry a 1911, I've got a hybrid

Wilson/stock Colt seven-rounder in the gun and two more Wilson mags behind my left hip in a spare mag pouch.

FLAWS IN THE BASIC DESIGN AND A PROPENSITY TOWARD SMALL PARTS BREAKAGE

Now, here's where I may get in trouble with a few folks. Some people seem to regard the basic 1911 design with an uncritical awe. To their minds, the 1911 represents handgun perfection; it is without flaws — without flaws, you hear me? Any criticism of the gun threatens their perceptions of the universe. Meanwhile, back in reality, the basic 1911 is an antiquated design and it is far from perfect (sacrilege, I know). Come on, folks, if John Browning was alive today, do you really think he'd be designing guns like the 1911? Hell no, (Actually, Browning had moved far beyond the 1911 by the time he died in 1926. In his prototype for the Browning Hi-Power, already completed at the time of his death, he did away with many of the flaws of the basic 1911 design.)

Without trying too hard, I can think of four flaws in the basic 1911 design that range from moderate to serious. Several areas of the gun are prone to small-parts breakage; In some cases, when these small parts let go, the gun is totally disabled and it'll take a pistolsmith to get it back up and running.

PROBLEM #1: THE SLIDE STOP:

A portion of the slide stop projects into the mag well for the purpose of engaging the magazine's follower and locking open the action when the gun is empty. Unfortunately, this also puts the slide stop almost in the path of a cartridge coming out of the magazine. Since the slide stop is only lightly spring-loaded into the down position, if a round of ammo nudges this part during the feeding cycle, it can pop up into the slide stop notch, locking the slide back with rounds still in the gun. This can get you killed. This malfunction usually occurs, if it occurs at all, when firing the gun with hardball and less commonly with shorter hollow-point rounds. If this hasn't happened to your gun, you probably have nothing to worry about; it's only a problem on certain guns. If you do have this problem, a good pistolsmith can dimple the slide stop where it touches the spring-loaded plunger. If the work is done to perfection, the slide stop will never pop up on you, but will still operate perfectly to lock open the empty gun.

PROBLEM #2: THE EXTRACTOR:

The amount of pressure a 1911's extractor places on a cartridge casing's rim is regulated by the curvature of the part in its channel through the slide. This is a crude system. Too much curvature means too much pressure, and the extractor will not allow a cartridge casing to slip up into place, resulting in a failure to feed. Not enough curvature means insufficient extractor tension, resulting in failures to fully extract and/or eject. Most modern firearms use spring-loaded extractors, a far more durable and reliable system. This is a major improvement in firearms design that seems to have passed by the 1911. The tension of a 1911's extractor can weaken with use. One sure way to screw up your extractor is to drop a round into the chamber with the slide open then drop the slide on the chambered cartridge. This will force the extractor to bend back and around the case rim, eventually abusing the extractor so much that it will lose its tension or even break off in extreme cases.

PROBLEM #3: THE BARREL BUSHING/RECOIL SPRING PLUG:

The barrel bushing/recoil spring plug is a high-stress area of the gun. Not only does the barrel whack around in the bushing every time you fire the piece, but the full force of the recoil spring also bears upon the bushing via the recoil spring plug. If the barrel bushing gives way, your recoil spring and recoil spring plug will depart the front of the gun at high speed. Effectively, the gun is disabled. Now, this doesn't happen very often, but I have had it happen to me while firing a Combat Commander. The bushing shattered, losing the semicircular piece that holds the recoil spring plug in the gun. My recoil system was somewhere down range, my gun out of action. I believe this occurred because the slide of my gun came from the factory slightly shorter in front than it should have been. There was a fingernail-size gap

between the barrel bushing's flange and the slide; you could move the bushing back and forth with your fingertips. This being the case, of course, the bushing took a hellacious pounding as it jacked itself back and forth every time the gun was fired, and finally it gave up the ghost. You should check your gun to ensure that the bushing fits snugly into the slide.

The exact same problem can occur from a different cause: The recoil spring plug may give way. This is common with hard use of the compact Officer's ACP guns. Most compact 1911s slavishly copy the Officer's ACP's recoil system, so this problem is not limited to Colts. On the Officer's ACP, the only thing holding the recoil spring plug in the gun is a tiny tab that hooks into a slot in the slide. If that small tab gives way (and it often does), your gun is hors de combat by virtue of a missing recoil system. I'm a big fan of the aftermarket recoil spring plugs for Officer's ACP-size guns that use a ring of metal at the rear of the plug to hold it inside the slide. There's no way such a part can come out of the gun.

PROBLEM #4: THE PLUNGER TUBE:

The plunger tube that runs between the slide stop and thumb safety is a notorious weak spot in the basic 1911 design. This tube contains two little plungers and a spring, the power of which serves both to hold the slide stop in the down position until operated by the follower of the empty magazine as well as to hold the thumb safety lever in the safe or fire position. This is a high-stress area of the gun; every time you flip your thumb safety on or off, you apply force to the plunger tube. Unfortunately, the plunger tube is held to the side of the gun only by two small studs that pass through holes in the frame. It is not at all unusual for one of these studs (almost invariably the rear one) to snap off. I've had this happen myself while shooting, and I've seen it happen to other shooters. When this happens, your thumb-safety lever will wind up in a half-on/half-off position. In an emergency, it would be possible to physically hold the safety lever down in the fire position and still shoot the piece. However, for all practical purposes, the gun is disabled until the plunger tube is replaced.

There's really nothing you can do about this problem except to keep a close eye on your gun's plunger tube for signs of looseness. Some folks say that if your plunger tube is loose, you should simply have it restaked. I don't know about that. If the plunger tube has been loose for any amount of time, that rear stud has probably been abused enough that I'd probably feel better myself simply replacing the tube with a new part. So, there's a lot to know about the ol' 1911, huh? It's not exactly the simplest or most maintenance-free design out there. The trick here is to enjoy the 1911 design for its strengths, but at the same time don't deny its weaknesses. Let me summarize my advice to maximize your 1911 auto's reliability: Load it with good hollow-point ammunition featuring a feed profile as close to hardball as possible. Use only top-quality magazines. Keep the gun clean and well lubricated. Check your bushing's fit in the slide. Regularly check your extractor tension and the plunger tube staked to the side of the gun for any looseness. If either of these areas shows problems, move instantly to rectify them. Modifications? Leave the gun as stock as possible. If you must customize, do so with extreme moderation. Either leave your hammer/sear alone or, if you must have a trigger job, let only a shop that knows what it's doing modify this critical area. If your slide stop is popping up, have the slide stop dimpled by a competent pistolsmith. On the small, Officer's ACP-size guns, replace the stock bushing with an aftermarket bushing designed to stay in the piece. Let only the best pistolsmiths touch your gun. I like to put my preferred sights on a 1911, but that's a matter of personal preference and not an absolute necessity. And that's about it.

You in the front row....yeah, you with your hand up. You have a question?

"So, you're saying that you've got to know the 1911 inside out to get the best out of it? You've got to know what ammo to feed it, buy good mags for it, know how the various parts work and know where the weak points are in the design so you can have advanced warning if anything's about to let go. Is the gun really worth all this effort?"

Emphatically, yes; the 1911 is worth it. The 1911's overwhelming virtue is how easy it is to shoot. Quite simply, the 1911 design gives us the shortest, most controllable trigger pull of any handgun. In this area,

all other one-hand guns must take a back seat to the grand old design. In my recent article on the easiest handguns to shoot, the Colt Government Model outshot several of the more modern designs, placing third out of five guns I tested. I believe it might have placed even higher, but I was determined that all the guns in my shootout be as stock as possible, so before testing the Government Model I replaced the excellent wooden Spengel grips the piece normally wore with the rubber wraparound grips that had come stock on the gun. The rubber wraparounds really bulked up the grip, changing a gun that had fit my hand wonderfully well into a gun that didn't fit my hand at all. The fact that I was still able to fire the piece well is, I feel, a tribute to the Government Model's inherent shootability.

Another thing I like very much about the 1911 is that it's the only serious, heavy-duty combat handgun out there that can be totally detail stripped without tools. Not to get too Zen here, but when I know I can totally disassemble my carry gun and put it back together again using nothing but my own hands, it gives me a wonderful sense of being one with the gun.

No, the 1911 is not a gun for the casually interested. However, for the dedicated shooter who's willing to take the time to get to know the design intimately, the 1911 is still a superior choice in a defensive handgun. Unlike most things in life, the 1911 has strengths that more than compensate for its flaws. If it's not perfect, well, what is??

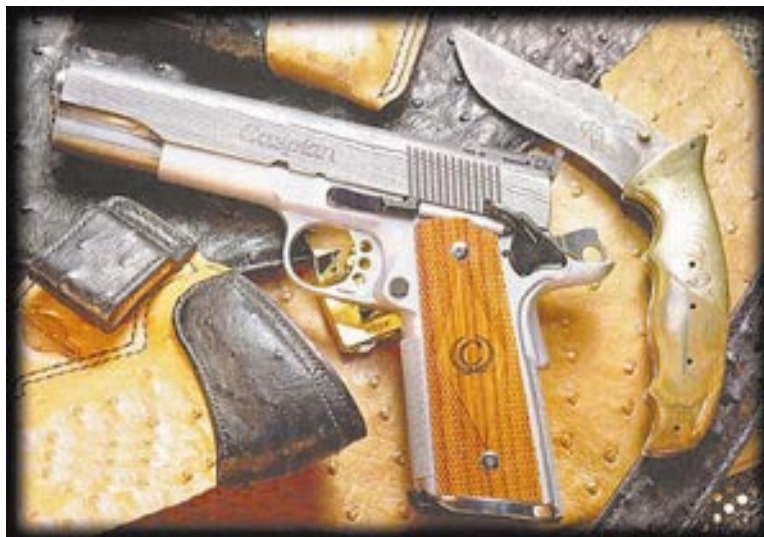

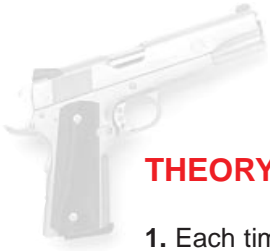

THEORY OF OPERATION COLT .45 ACP GOVERNMENT MODEL PISTOL

1. Each time a cartridge is fired, the parts of the pistol function in a given order. The cycle of functioning is divided into eight steps. It should be kept in mind that more than one step may occur at the same time. Assume for the purposes of this discussion that a loaded magazine is in the weapon and a live cartridge is in the chamber. The hammer is fully cocked, the safety lock is off, the grip safety is depressed, the trigger is squeezed and the round is ignited. The cycle of functioning begins.

2. Chambering – At the termination of the rearward movement of the slide, the expanding recoil spring forces the slide forward. The lower portion of the face of the slide passes between the lips of the magazine, strips the top cartridge from the magazine and pushes it to the bullet ramp and up into the chamber. During this movement, the base of the cartridge slides up the face of the slide. At this time, the extractor enters the extracting groove in the head of the cartridge. Chambering is complete when the cartridge is fully seated in the chamber and the face of the slide is against the rear extension of the barrel.

3. Locking – After chambering is completed, the slide continues forward and pushes the barrel forward. As the slide continues to exert force against the rear of the barrel, the barrel pivots up and forward of the barrel link. At this time, the locking ribs on the barrel enter the locking recesses in the underside of the slide. The forward movement of the recoiling parts terminates when the barrel lugs strike the slide stop pin.

4. Firing – When the grip safety is depressed and the trigger is squeezed, the trigger bar presses against the disconnecter which in turn transmits this movement to the sear. The sear rotates on the sear pin and disengages from the full cock notch of the hammer. The expanding mainspring pushes the hammer strut up, rotating the hammer to rotate forward on the hammer pin and strike the firing pin. The inertia firing pin travels forward, compressing the firing pin spring. The firing pin moves through the firing pin well in the face of the slide and strikes the cartridge's primer. The primer ignites the propellant and the expanding gases force the bullet through the barrel. The firing pin spring expands and withdraws the firing pin from the face of the slide.

5. Unlocking – As the gases expand, equal pressure is exerted in all directions. These gases force the bullet down the barrel and force the slide to the rear. As the slide moves to the rear, it carries the barrel with it. The barrel link pivots about the slide stop pin, which is attached to the stationary receiver, and draws the barrel downward as well as to the rear. As the barrel is pivoted downward, the barrel locking ribs are disengaged from the locking recesses in the slide and unlocking is completed.

6. Extracting – The slide continues its rearward movement and the extractor, engaged in the extracting groove of the cartridge, withdraws the cartridge case from the chamber. Extracting is completed as the cartridge clears the chamber.

7. Ejecting – As the slide continues to move to the rear, the cartridge case, which is held against the face of the slide by the extractor, strikes the ejector on the receiver, pivots on the extractor and is ejected from the pistol through the ejection port.

8. Cocking – Cocking begins as the slide starts rearward in recoil. The firing pin stop pushes the hammer rearward and the hammer strut is pushed down against the mainspring cap, compressing the mainspring. Rearward movement of the slide terminates as the lower projection of the slide strikes the recoil spring guide. The expanding recoil spring causes the slide to begin its forward movement. As the slide moves forward, the hammer follows the slide for a short distance; then the sear, which is bearing against the hammer through the action of the sear spring, enters the full cock notch of the hammer and holds it in the cocked position. When the slide is fully forward and the trigger is released, the disconnecter positions in its recesses in the bottom of the slide and cocking is completed.

Source for the above information: *Guidebook for Marines - 14th edition*



DISCONNECTOR, SEAR, SEAR SPRING AND SAFETY LOCK OPERATION

DISCONNECTOR

1. The disconnector sits forward of the sear. There is a paddle on the bottom of the disconnector. When the slide is in battery (at its most forward position), the top of the disconnector rides up to fit in a 0.4 inch long slot in the bottom of the slide. The “rest” or “up” position of the disconnector causes the top of the disconnector to be exposed about 0.06 inches above the frame.
2. The paddle area of the disconnector is pressed by the disconnector spring prong against the back of the trigger bow.
3. When the slide is in battery with a live round in the chamber, the hammer cocked, the safety lock off, the grip safety depressed and the trigger pulled, the rear lateral bar of the trigger bow presses against the front side of the disconnector’s paddles. The disconnector begins to pivot around the sear pin. As the rear side of the disconnector’s paddles move aft, they contact the forward side of the sear’s feet. The sear’s feet move rearward as the sear begins to pivot, along with the disconnector, around the sear pin. As the sear’s feet are pushed rearward, the sear’s beveled nose moves forward. The beveled nose is engaged in the hammer’s notches. When the sear has been rotated enough to cause the sear’s beveled nose to withdraw from the hammer’s full cock notches, the hammer, under mainspring pressure directed up the hammer strut, moves rapidly forward. The hammer strikes the firing pin, which in turn strikes the primer, and the cartridge is fired.
4. When the slide is drawn rearward, whether manually or by the force of the recoil, the top of the disconnector is pressed downward. The paddles at the bottom of the disconnector, which normally rest just in front of the bottom feet of the sear, move downward as the top of the disconnector is depressed by the slide and the disconnector’s paddles clear the feet of the sear. When the disconnector’s paddles clear the sear’s feet, pulling the trigger will not move the sear at all.

SEAR

1. The purpose of the sear is to hold the hammer back by having the sear’s beveled nose inserted into either the half cock or full cock notches of the hammer. When the sear is in the half cock notch of the Series 70 and earlier pistols (with the safety lock off and the grip safety depressed), pulling the trigger will not cause the sear to move out of the half cock notches and permit the hammer to fall. In the Series 80 pistols, pulling the trigger with the hammer at the half cock position will permit the hammer to safely fall to the “rest” position.
2. When the sear is in the full cock notches of the hammer (with the safety lock off and the grip safety depressed), pulling the trigger causes the sear’s nose to move out of the full cock notches and permit the hammer to fall against the firing pin.

SEAR SPRING

1. The sear spring is a three pronged spring which fits into a slot in the mainspring housing area at the rear of the frame. The left spring prong is the actual sear spring, the center prong is the disconnector spring and the right prong is the grip safety spring. There is a 90° bend at two places in the spring. The bottom end of the spring has a 90° bend in it to permit it to slip into the slot in the rear of the frame. This acts to anchor the spring unit. The other 90° bend is on the sear spring prong and is provided to permit the spring prong to ride on the minimum possible surface area of the sear’s left foot.
2. The sear spring prong presses forward against the rear of the left sear foot, which causes the sear’s beveled nose to push rearward with force. This engages the sear firmly in the hammer’s notches.

3. The disconnecter spring prong presses forward against the rear center of the disconnecter's paddle area. This moves the paddles forward and positions the disconnecter's paddle area about 0.2 inches forward of the rear of the sear's feet. The front of the disconnecter paddle area presses forward against the rear of the lateral bar on the trigger bow and forces the trigger to move to its most forward position. Thus, the disconnecter spring prong acts as a trigger return spring as well as serving to rotate the paddles of the disconnecter forward of the sear's feet.

4. The grip safety spring prong is arched rearward. The tip of the grip safety spring prong rides below a bar on the right forward side of the grip safety. The grip safety pivots about the safety lock pin. The bar on the right forward side of the grip safety has a cutout in it, creating a protruding tip.

5. When the pistol is at rest with no forward pressure being applied against the rear of the grip safety, the rearward acting pressure of the grip safety spring prong pushes against the forward side of the grip safety. This causes the top of the grip safety to pivot forward. As it pivots forward, and the rear section of the grip safety pivots rearward, the tip of the bar on the right forward side side of the grip safety lowers against the right side of the rear of the lateral bar on the trigger bow. Because the tip is aligned behind the trigger bow, the trigger cannot be pulled.

6. When the grip safety is being normally depressed by the web of the shooting hand, the lower section of the grip safety pivots forward (the top section pivots rearward) and the tip of the bar on the right forward side of the grip safety moves above the lateral bar on the trigger bow. Since there is now no restraint against the trigger bow, the trigger may be pulled rearward to fire the weapon.

7. As soon as the forward acting pressure from the web of the shooting hand is released, the grip safety pushes rearward against the grip safety body and again causes the pivoting action of the grip safety to position the tip of the bar against the rear of the trigger bow.

SAFETY LOCK

The safety lock is located on the left side of the frame. Its purpose, when engaged, is to prevent the sear from moving when the trigger is pulled and the hammer is in the full cock position. On the inside portion of the safety lock is a stud which will move to the shoulder area of the sear (that portion of the sear directly above the feet) when the safety lock is moved upward to the engaged position. The safety lock cannot be engaged unless the hammer is in the full cock position.

This article was compiled by Richard M. Bash of Combat Arms,
2869 Grove Way,
Castro Valley, California 94546-6709,
telephone (415) 538-6544





In Praise of the M1911 .45 ACP

Why this classic pistol remains the standard of comparison!

By Chuck Taylor

Though it's been in continuous service for 87 years, the venerable Colt model 1911 in .45 auto is still the premier self-loading combat pistol. In fact, it dominates nearly every facet of handgunning, from the national matches at Camp Perry, to IPSC competition, to the hunting and boondocking field, to the Sands of Iwo Jima, and even the streets of San Francisco!

And in its thus-far unparalleled tenure as a general-purpose service pistol it has seen a multitude of modifications and has seen use in virtually every kind of natural and tactical environment as well. Old Ugly has been cussed and discussed more than any other handgun in history, and continues to ride an unprecedented wave of popularity shared by no other handgun.

We're often told these days that the M1911 is an antique and an anachronism belonging to a by-gone age. Some say that its condition one (cocked and locked) mode of carry for imminent use is unsafe or politically incorrect and claim that it lacks mechanical reliability or is inaccurate. Others say that training to use it safely requires too much training and that such training isn't time or cost-effective in comparison to a DAO revolver or self-loader.

And yet in spite of its critics, the M1911 continues to be the preferred handgun of millions, be they competitive shooters, police officers, personal defense oriented civilians or military personnel. How can this be? What is it about the M1911 that the so fascinates so many people? And if it really is inaccurate or unsafe or unreliable, how can such a rapt fascination have ever occurred in the first place, much less continued to the legendary levels seen today?

The answer is deceptively simple really. The M1911 isn't inaccurate, nor is it mechanically unreliable; nor is that unsafe. What it is is simple; no more, no less. In its target configuration, it holds most of the records at Camp Perry, the premier accuracy contest of all. And, in slightly altered target form, it remains the dominant pistol for all IPSC shooting, too. Obviously, were it inaccurate, this situation could not exist. The culprit here is a bias and assumption. If we recover a rusty M1911 from the sand at Omaha Beach, clean it up and shoot it, it will generally keep all of its shots inside a ten or twelve-inch circle at 50 meters. To a target shooter, this won't do, but for a soldier, this is more accuracy than he can use.

If we take a typical M1911, hold it in our hand and briskly shake it, we note that it rattles slightly, another characteristic generally assumed to cause less accuracy but such is untrue. I have a first-production run M1911 that rattles as described, but from a Ransom Rest with nearly any kind of 230-grain FMJ (ball) ammo, it prints three shots into one-inch at fifty meters, time after time. Is that accurate enough for you? It sure is for me! And this also shows that tight tolerances aren't the only issue to consider where accuracy is concerned.

What's really important is that the moving parts go back to the same place each time, even when fouling is present, not how tight everything is. This is why all service pistols seem a little loose—they need such tolerances to function in the widest possible variety of environments. In a bullseye match, we may get an alibi if our pistol malfunctions because it's too tight and doesn't function reliably, but when you life's on the line, there are no alibis.

In short, one doesn't use a target pistol for self-defense in the real world; nor does he use a service pistol for an extreme accuracy contest like bullseye shooting. It all boils down to selecting the right tool for the job, not the other way around. So assuming that because a given M1911 rattles a bit, it's inaccurate is a serious error.

Moreover, much of the weapon's legendary status was achieved because it has repeatedly demonstrated excellent mechanical reliability under an awesome variety of field conditions-in heat and cold, wet or dry, in mud or dust. It could not have survived past the first few occasions in which it was used, much less survived and proliferated to its current status otherwise.

Another erroneous assumption is that because of its single action mode of functioning, the M1911 is somehow unsafe or that it requires more training than other weapon types. Negligent discharges are caused by inept gun handling (a training function) or occur because someone has butchered the weapon's internal parts (a gunsmithing function), not because its design is inherently invalid. Too many years of history show otherwise, as do the number of other weapons utilizing the same concept. Another reason the M1911 is so popular is because it's so easy to work with under stress. It's controls are well-located for quick, efficient use and require no fine motor skill to operate, a major advantage when the adrenaline is pumping through your veins like a high-pressure pipeline. In fact, the slide stop/release, magazine release button and thumb safety of the M1911 are so easy to operate that no additional training is required. Even when the gun is being presented from a holster, proper training technique incorporates disengagement of the thumb safety at the appropriate time. As practical firearms go, we'll search far and wide for something as easy to use effectively, particularly under stress, as Old Ugly.

In addition to its other combat-proven features, the M1911's caliber is also a major reason for its reputation. The .45 ACP cartridge was specifically created for and made its first appearance in the M1911 and has earned an unequalled reputation for not only inherent accuracy but stopping power against armed and determined adversaries as well. As this is written, the .45 ACP can be found in nearly every possible bullet weight, configuration and load specification-a true cartridge for all seasons. Virtually every one exhibits more accuracy than all but the most accomplished shooter can actually use, functions well, and produces manageable recoil, making it suitable for a very wide spectrum of missions, from self-defense, to target shooting, to hunting, to general boondocking functions. No other cartridge in existence-even the 357 Magnum-can claim such high marks in all of these areas.

The M1911's critics are almost always those whose perspective isn't sufficiently clear to understand it, and this prevents objectivity. The fact is that, like it or not, the M1911's popularity is based clearly and definitively on its superior physical characteristics and a nearly century-long record of superior performance. This is a matter of record and is the direct result of its unique combination of accuracy, mechanical reliability, and "user friendliness" (especially under stress).

In fact, the M1911's record is so good, that it's built by more manufacturers than any other handgun today, in more different versions and is the basis for the widest array of custom guns in history. Let's be real here-were it intrinsically faulty, none of this could have happened.

So, if you've heard that Old Ugly is on the way out, you'd better look again, for such is simply untrue; quite the opposite. Everything it has had the capacity to do for the last eight and a half decades remains valid. It thus remains King Of The Hill and will likely continue to do so well into the next millennium. To produce a handgun with better or more practical capabilities will be difficult and perhaps impossible. And I, for one, feel that we can look forward to watching the M1911 continue to dominate the handgun world well into the foreseeable future.

Thanks to Chuck Taylor for permission to use this article.

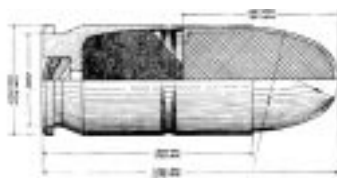



Concealed Carry and the "Large" Auto Pistol

By Jim Higgenbotham

I run into people all of the time who think that they must have a small handgun in order to conceal it. I am reminded of the time when eminent authority and author Tom Givens and a fellow off duty officer were cooling off from the summer heat at the local indoor range - you look for alcoholics at the local tavern, you look for "gunaholics" at the range or gun shop. They became engaged in conversation with a customer who was waxing eloquent on the virtues of this or that weapon in the gun case. Eventually he allowed as the .45 auto was a fine weapon but of small use to most people since they couldn't hide one. Tom told him that it was indeed possible to hide a .45 if one used the right holster, which brought a rebuttal that there was no right holster, the gun was simply too big. This discussion went back and forth for some time until my friend Tom ended all debate by pulling his Government Model out from under his cotton shirt, worn with the tail out, and placed it on the counter. I have seen him pass close inspection by a police officer - though not a frisk - when he was wearing a T-shirt. Tom, by the way, seldom even has to resort to inside the pants holsters to hide his weapon.

Folks who are new to carrying weapons concealed are a bit self-conscious about the matter. They think every one can see them. I have worn a concealed weapon for over 25 years and have never had anyone inadvertently discover that I was armed. Once I was even frisked by a federal officer who failed to find my Star PD .45. Of course I was carrying it legally and it would not have mattered if he did find it.

None of this should be taken as a suggestion that you should be complacent about concealing your weapon. If you are one of those who has an inborn desire to be "seen of men" and think having a concealed carry permit makes you something special, and you would really like someone to ask you what that bulge is under your arm, then you need more help than I can give. This is not a game. One of the reasons to conceal weapons today is tactical. If the bad guys can tell you are armed before the fight starts you just may take a bullet in the back of the head before you even know there is a fight on. Don't just cover up your weapon CONCEAL it! At any rate, there are those who feel that the .45 Government Model, or one of its variations or copies, is the finest fighting sidearm ever produced. With some reservations (see the chapter on custom modifications) I agree. But I began my education on weaponcraft back when there were very few serious options. Today we have several adequate designs which will suffice quite well.

Personally, I can do more with this gun than with any other. My "hammers" (two very fast shots with one sight picture) are in the neighborhood of .15 to .17 seconds apart, something I cannot even improve on when I use a .22 auto. My trigger finger simply won't operate faster - old age I guess. These rounds will impact in the vital zone about 95% of the time back to about 7 yards (further if I practice regularly) Perhaps one reason is that I have shot one so much with this type of weapon (about 250,000 rounds) that it is second nature to me. But try as I might I cannot get hammers this quick or accurate with a double action. auto. I can keep the rounds pretty close together with the Glock and the DAO autos as well as DA revolvers but the time creeps up to around .20 seconds between shots. This might seem adequate - and probably is - but why take the lower level of performance if you do not have to.

While the reliability of the Colt .45 auto - a John Browning design - is legendary, I must point out that this reputation is built using full metal jacket (FMJ) or "ball" ammo. With today's JHP bullets it is not as sure fire unless the weapon has been "throated" to feed the alternative styles of ammo. Modern Colts are designed to feed modern bullets as are most of the copies, never the less I have seen plenty of new examples that needed some attention in order to feed 100%. The key is to shoot your new gun about 200 rounds with the ammo you intend to carry. If you have a malfunction then seek help. But then again this is true of any weapon you may purchase, either new or used.

Two variations of the Government Model, the Commander and the Combat Commander might be

considered by some to be compacts but since only the barrel and slide have been cut back 3/4 inch I do not consider it so. Still, they are fine weapons for concealed carry and the 3/4" may allow you to more comfortably hide a weapon in an outside the pants holster. These weapons are about the same size as any duty type auto on the market today and so are a good choice.

The Commander, which has an aluminum frame weighs in at 27 ounces empty while the all steel Combat Commander is around 34 ounces. There are literally millions of used .45s out on the market and, barring abuse, it is difficult to wear one out. The only trouble with the older guns is that the sights were a bit difficult to see but this can be fixed (see the chapter on modifications). Magazines for this weapon are as common as dirt but beware there are some really poor aftermarket suppliers which sell real junk.

As mentioned there are many makers who are producing copies of this weapon. Their quality can range from outstanding to really poor so "buyer beware". It is not our intent here to run down any maker's product but to encourage you to investigate and find out what works. I will say that the new Kimber Custom 1911a1 is one of the best examples of a Government Model I have encountered - including some of the standard package guns of big name gunsmiths! Also you should know that Colt Series 80 and Para Ordinance guns are equipped with a firing pin safety which blocks the firing pin except when the trigger is pulled.

The above was written several years ago. Today as we near the Millenium, I believe it still holds true - it is a testament to John Browning that nearly 90 years (the model of January 1910 was essentially the same as the 1911) after its birth the 1911 remains the finest combat pistol ever made en masse.

DVC

Jim Higginbotham

Thanks to Jim for permission to use this article



In Closing...

A lot of people believe that the 1911-pattern pistol is the greatest combat handgun ever built. I certainly wouldn't argue with them, although I am aware that some other good pistols have been designed since 1911. It remains one of the best fighting guns ever, although the single action design has become something of a liability in this hoplophobic milieu in which we live.

Rather than stoking the "best" argument which is truly endless and without resolution, I will say only that the 1911 occupies a very special place in the history of combat weaponry, and in the hearts of pistoleros everywhere. It was the 1911 in the hands of Cpl. York which brought down the German patrol, which downed the Zero for 2nd Lt. Bagget, and fought until dawn against overwhelming odds with Kouma, Basilone, and Schmid. It was the 1911 which lay under John Dillinger's pillow and dangled from the drunken hand of Machine Gun Kelley at his capture. Bonnie Parker died with one on her lap. This rich history coupled with the superb performance of the pistol is unique and will never be duplicated.

This little book is truly my "notebook" on the 1911. It is a collection of articles, databits, and material I've either created or "borrowed". Nothing in it is gospel and technical information, such as loads and gunsmithing tips should be verified by other sources and careful testing. The book will no doubt change as I collect and write more information, so check back from time to time on the website for newer revisions.

Syd Weedon

sydw@sydwdn.win.net

<http://www.win.net/~sydwdn/1911/1911.htm>

Revision Date: 10/22/99

